



**Features**

- Interdigitated amplifying gates
- Fast turn-on and high di/dt
- Low switching losses

**Typical Applications**

- Inductive heating
- Electronic welders
- Self-commutated inverters

**$I_{T(AV)}$  1500A**  
 **$V_{DRM}/V_{RRM}$  1900~2200V**  
 **$t_q$  20~40 $\mu$ s**  
 **$I_{TSM}$  18 kA**  
 **$I^2t$  1620 10<sup>3</sup>A<sup>2</sup>S**

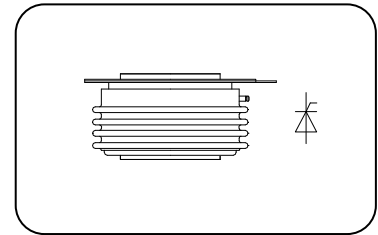

SYMBOL	CHARACTERISTIC	TEST CONDITIONS	$T_j(^{\circ}C)$	VALUE			UNIT
				Min	Type	Max	
$I_{T(AV)}$	Mean on-state current	180° half sine wave 50Hz Double side cooled, $T_c=55^{\circ}C$	125		1500	1750	A
$V_{DRM}$ $V_{RRM}$	Repetitive peak off-state voltage Repetitive peak reverse voltage	$V_{DRM} \& V_{RRM}$ , $t_p=10ms$ $V_{DSM} \& V_{RSM} = V_{DRM} \& V_{RRM} + 100V$	125	1900		2200	V
$I_{DRM}$ $I_{RRM}$	Repetitive peak current	$V_D = V_{DRM}$ $V_R = V_{RRM}$	125			120	mA
$I_{TSM}$	Surge on-state current	10ms half sine wave	125			18	kA
$I^2t$	$I^2t$ for fusing coordination	$V_R = 0.6V_{RRM}$				1620	A <sup>2</sup> s*10 <sup>3</sup>
$V_{TO}$	Threshold voltage		125			1.48	V
$r_T$	On-state slop resistance					0.28	m $\Omega$
$V_{TM}$	Peak on-state voltage	$I_{TM}=3000A$ , $F=28kN$	25			3.15	V
dv/dt	Critical rate of rise of off-state voltage	$V_{DM}=0.67V_{DRM}$	125			1000	V/ $\mu$ s
di/dt	Critical rate of rise of on-state current	$V_{DM}=67\%V_{DRM}$ , $I_{TM}=(2-3)I_{T(AV)}$ , $t=5s$ , Gate pulse $t_r \leq 0.5\mu s$ $I_{GM}=1.5A$ $f=50Hz$	125			600	A/ $\mu$ s
$Q_{rr}$	Recovery charge	$I_{TM}=1500A$ , $t_p=1000\mu s$ , $di/dt=-20A/\mu s$ , $V_R=100V$	125		800		$\mu C$
$t_q$	Circuit commutated turn-off time	$I_{TM}=1500A$ , $t_p=1000\mu s$ , $V_R=100V$ $dv/dt=30V/\mu s$ , $di/dt=-20A/\mu s$	125	20		40	$\mu s$
$I_{GT}$	Gate trigger current			40		200	mA
$V_{GT}$	Gate trigger voltage	$V_A=12V$ , $I_A=1A$	25	0.9		2.5	V
$I_H$	Holding current			20		300	mA
$V_{GD}$	Non-trigger gate voltage	$V_{DM}=67\%V_{DRM}$	125			0.3	V
$R_{th(j-c)}$	Thermal resistance Junction to case	At 180° sine double side cooled Clamping force 28kN				0.016	$^{\circ}C/W$
$R_{th(c-h)}$	Thermal resistance case to heat sink					0.004	
$F_m$	Mounting force			23		32	kN
$T_{stg}$	Stored temperature			-40		140	$^{\circ}C$
$W_t$	Weight				650		g
Outline	KT65cT						

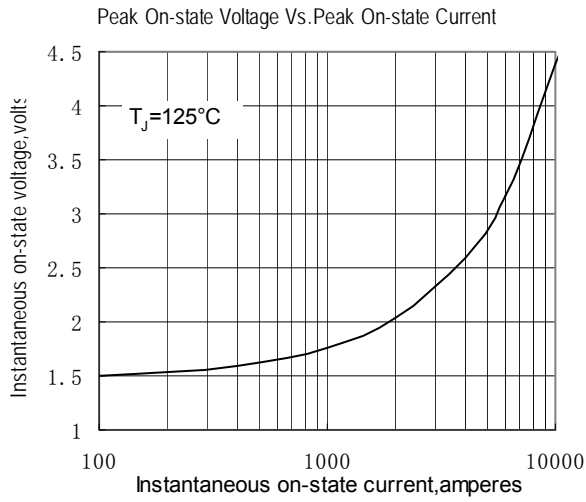

Fig.1

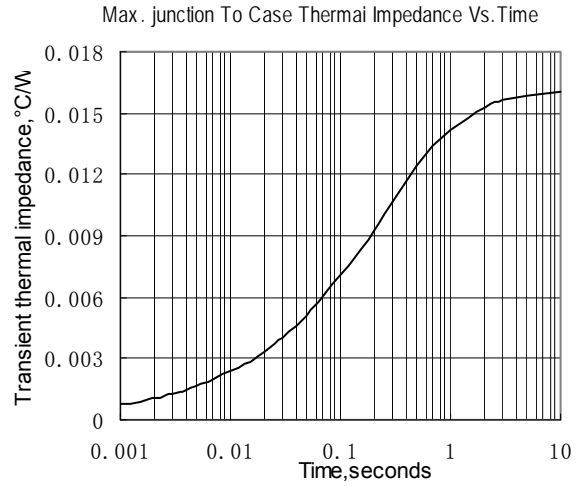

Fig.2

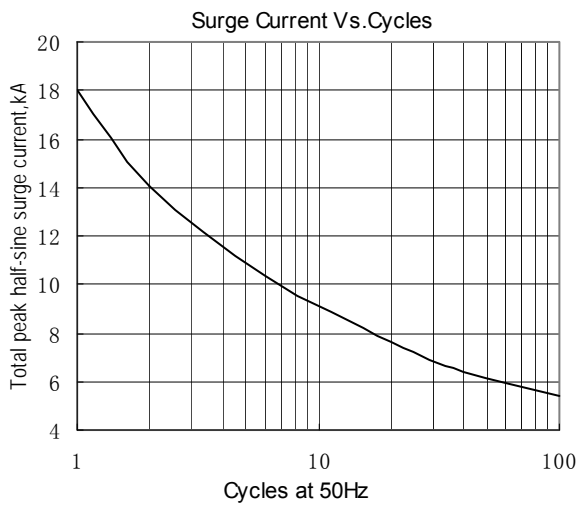

Fig.3

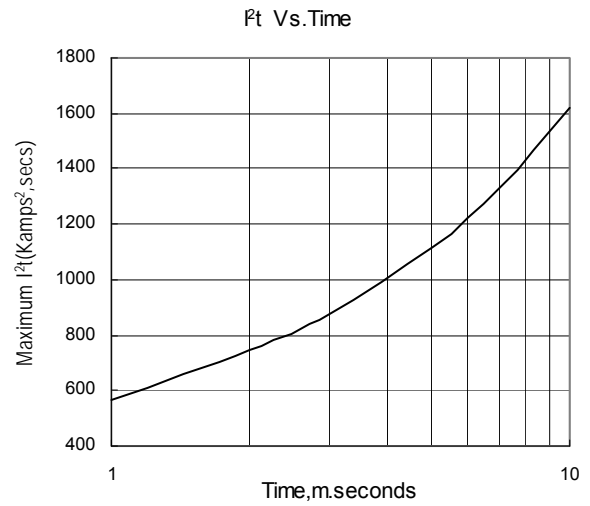

Fig.4

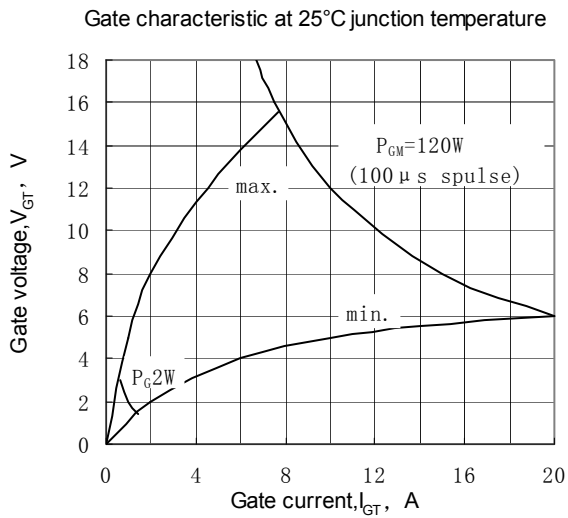

Fig.5

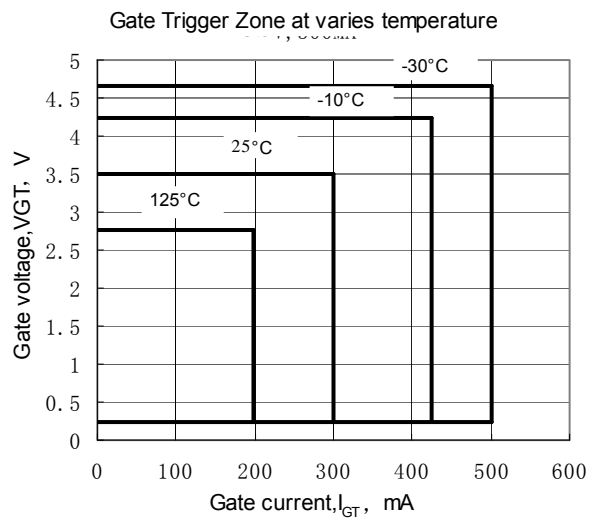
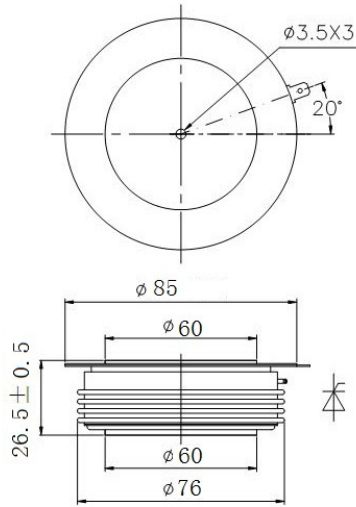

Fig.6



Outline:

图11-KT65cT



地 址 Address: 辽宁省锦州市滨海新区黔江街21号

邮 编 Zipcode: 121007

电 话 Telephone: 0416-2936666 18840127688

传 真 Fax: 0416-2936888

网 址 Web Sit: <http://www.power-semi.com>

电子邮箱 Email: 13904168481@126.com