

ISTA 6 Series
Member
Performance
Test
PROJECT*

VERSION
DATE

Last
TECHNICAL
Change:
March
2018

Last
EDITORIAL
Change:
MARCH
2018

For complete
listing of
Procedure
Changes and
Version Dates
go to
www.ista.org

ISTA, Distributing Confidence, Worldwide™

ISTA® 6-Series *Member Performance Tests* are protocols created by ISTA members to suit their own particular purposes and applications. This 6-AMAZON.COM test was developed by ISTA in cooperation with Amazon.com, and is designed as a General Simulation protocol. General Simulation tests

- Challenge the capability of the package and product to withstand transport hazards, **but**
- Utilize general simulation of actual transport hazards, **and**
- Do not necessarily comply with carrier packaging regulations.

When properly executed, ISTA procedures will provide tangible benefits of:

- Product to market time reduction
- Confidence in product launch
- Reduction in damage and product loss
- Balanced distribution costs
- Customer satisfaction contributing to increased market share

There are three sections to this procedure: Overview, Testing, and Reporting

- **Overview** provides general knowledge required before testing **and**
- **Testing** presents the specific instructions to do laboratory testing **and**
- **Reporting** indicates what data shall be recorded to submit a test report.

Two systems of weights and measures are presented in ISTA test procedures: English system (Inch-Pound) or SI (Metric). Inch-Pound units are shown first followed by the Metric units in parentheses; there may be exceptions in some tables (when shown separately).

Familiarity with the following units and symbols used in this document is required:

For measuring	English units and symbols	Metric units and symbols
Weight	pounds (lb)	kilograms (kg) or grams (gm)
Force	pounds force (lbf)	newtons (N)
Distance	feet (ft) or inches (in)	meters (m) or millimeters (mm)
Velocity	inches per second (in/sec)	meters per second (m/sec) or millimeters per second (mm/sec)
Volume	cubic inches (in ³)	cubic centimeters (cm ³) or cubic meters (m ³)
Density	pounds per cubic inch (lb/in ³)	kilograms per cubic meter (kg/m ³)
Temperature	Fahrenheit (°F)	Celsius (°C)

- Either system may be used as the unit of measure, **but**
- The units chosen shall be used consistently throughout the procedure.
- Units are typically converted to two significant figures **and**
- Not exact equivalents.

VERY IMPORTANT:

The entire document shall be read and understood before proceeding with a test.

* Notes Regarding ISTA "Projects" and "Procedures"

- ISTA® 6-AMAZON.COM is currently an ISTA "Project", first released in October 2014. New ISTA test protocols are given the designation "Project" during their implementation phase. After a minimum one-year period and required evaluation, a "Project" will either be adopted as an established "Procedure", revised and kept as a "Project" for another period of time, or be dropped. Therefore, a "Project" is potentially subject to greater and more frequent revision than a "Procedure".
- ISTA members may use either Procedures or Projects for package certification.
- Comments regarding this Project and its use are encouraged and welcome. Please contact ista@ista.org.

OVERVIEW OF PROJECT 6-AMAZON.COM-SIOC

Project 6-AMAZON.COM is a general simulation test for “Ships In Own Container” (SIOC) packaged-products shipped through Amazon’s distribution system to final customer destinations. This testing protocol has been developed by combining data from previous studies of transportation environments, relevant testing protocols, Amazon Fulfillment Center environment visual observations, and customer feedback.

This test is for packaged-products shipped by Vendors to Amazon.com Fulfillment Centers and delivered to final customer destinations via Parcel or Less-Than-Truckload (LTL) outbound shipment methods. It challenges the capability of both package and product to withstand transport hazards normally encountered during handling and transportation. Amazon.com Vendors with items intended to utilize Ships In Own Container (SIOC) are encouraged to use this test to understand the protective performance of their packaging.

Project 6-AMAZON.COM has been created by Amazon.com with help from industry experts in both the packaging and transportation industries. This test is currently in the Project phase (pilot stage) and will be improved upon if/where needed using feedback from industry experts and users of the test. It is requested that you share feedback and other data from any testing conducted using this test including number of tests conducted, failure/success rate, types of failures, test performance compared to real world comparison, and any other helpful data points. Please share your feedback with package-testing@amazon.com Amazon.com will share this data with ISTA in an effort to improve the effectiveness of the test protocol.

Project 6-AMAZON.COM is appropriate for eight (8) different types of packaged-products designated Types A through H below. The different types are a combination of four (4) packaged-product criteria: Amazon.com Outbound Shipment Method, Amazon.com Fulfillment Center Handling Method, Packaged-Product Weight, and Product Category. See **Definitions** below for an explanation of packaged-product types and other terms used in this document.

Packaged-Product Test Types

- **Type A:**
 - **Shipment Method:** Parcel Delivery of Individual Packaged-Products
 - **Handling Method:** Standard Handling Method
 - **Weight & Dimensions:** Less than 50 lb (23 kg) & Girth equal to or less than 165” (4.19 m)
- **Type B:**
 - **Shipment Method:** Parcel Delivery of Individual Packaged-Products
 - **Handling Method:** Standard Handling Method
 - **Weight & Dimensions:** 50 lb (23 kg) to Less than 100 lb (45 kg) & Girth equal to or less than 165” (4.19 m)
- **Type C:**
 - **Shipment Method:** Parcel Delivery of Individual Packaged-Products
 - **Handling Method:** Standard Handling Method
 - **Weight & Dimensions:** 100 lb (45 kg) or Greater & Girth equal to or less than 165” (4.19 m)
- **Type D:**
 - **Shipment Method:** Less-Than-Truckload (LTL) Delivery of Individual Packaged-Products
 - **Handling Method:** Standard Handling Method
 - **Weight & Dimensions:** Less than 100 lb (45 kg) or Girth greater than 165” (4.19 m)
- **Type E:**
 - **Shipment Method:** Less-Than-Truckload (LTL) Delivery of Individual Packaged-Products
 - **Handling Method:** Standard Handling Method
 - **Weight & Dimensions:** 100 lb (45 kg) or Greater or Girth greater than 165” (4.19 m)
- **Type F:**
 - **Shipment Method:** Less-Than-Truckload (LTL) Delivery of Individual Packaged-Products
 - **Handling Method:** Pallet Handling Method
 - **Weight & Dimensions:** N/A & N/A
- **Type G:** TV/Monitor
 - **Product Category:** TV/Monitor
 - **Shipment Method:** Parcel Delivery of Individual Packaged-Products
 - **Handling Method:** Standard Handling Method
 - **Weight & Dimensions:** Less than 150 lb (68 kg) & Girth equal to or less than 165” (4.19 m)
- **Type H:** TV/Monitor
 - **Product Category:** TV/Monitor
 - **Shipment Method:** Less-Than-Truckload (LTL) Delivery of Individual Packaged-Products
 - **Handling Method:** Standard Handling Method
 - **Weight & Dimensions:** 150 lb (68 kg) or Greater or Girth greater than 165” (4.19 m)

Packaged-Product Criteria

- **Amazon.com Outbound Shipment Method:**
 - Parcel Delivery of Individual Packaged-Products
 - Less-Than-Truckload (LTL) Delivery of Individual Packaged-Products
 - Packaged-Product Weight Greater than 150 lb **or**
 - Any Packaged-Product Dimension Greater than 108 inches **or**
 - Packaged-Product Girth Greater than 165 inches (4.19 m) (Girth = Length + 2 * (Width + Height)) **or**
 - Palletized Packaged-Product **or**
 - Special Delivery Requirement by Amazon
- **Amazon.com Fulfillment Center (FC) Handling Method:**
 - Standard Handling Method (Floor Loaded) – Individual packaged-products that are received at Amazon.com Fulfillment Center with no pallet or with multiple packaged products on a single pallet and are intended to ship to the end consumer without a pallet.
 - Pallet Handling Method - Individual packaged-products that are received at Amazon.com Fulfillment Center on its own individual pallet and is intended to ship to the end consumer on a pallet.
- **Weight of Packaged-Product:**
 - Less than 50 lb (23 kg)
 - 50 lb (23 kg) to Less than 100 lb (45 kg)
 - 100 lb (45 kg) or Greater
- **Product Category:**
 - TV/Monitor - Any package which contains as a primary product a TV or a Monitor. This product category has been identified due to unique product attributes and inherent areas of fragility, in combination with distinct handling practices.

Definitions

- **Parcel Delivery.**
 - Any individual packaged-product shipped by Amazon.com to the consumer via a Parcel delivery system such as UPS, FedEx, etc. **(including elongated and flat packaged-product)**
 - **Less than Truckload (LTL) Standard Packaged-Product**
 - Any packaged-product shipped by Amazon.com to the consumer via an LTL delivery system **(including elongated and flat packaged-product)** that is not palletized or skidded
 - **Less than Truckload (LTL) Palletized Packaged-Product**
 - Any packaged-product shipped by Amazon.com to the consumer via an LTL delivery system **(including elongated and flat packaged-product)** that is individually palletized or skidded
 - **Standard and Custom Pallet.** A standard pallet is a design which is in wide industry use, with published specifications, quality, and applications, used within those specifications and in a typical application. Standard pallets have information, provided by their manufacturers or distributors, available on the internet. A custom pallet is one designed for a specific product or narrow range of products, and with its design and performance characteristics not widely known or published.
 - **Elongated Packaged-Product**
 - A packaged-product where the longest dimension is 36 in (910 mm) or greater **and**
 - both of the other dimensions are each 20 percent or less of the longest dimension
 - **Flat Packaged-Product**
 - A packaged-product where the shortest dimension is 8 in (200 mm) or less **and**
 - the next longest dimension is four (4) or more times larger than the shortest dimension, **and**
 - the volume is 800 in³ (13,000 cm³) or greater
- NOTE:** If a packaged-product is both Elongated and Flat in accordance with the above definitions, it should be tested as Elongated.
- **Non-Rigid Containers** are defined as having one or more of the following characteristics:
 - the outer package may offer insufficient protection from concentrated low-level impacts **or**
 - the design has large unsupported spans of outer packaging material **or**
 - the outer package utilizes a stretch- or shrink-wrap design, a thin-flute or light grade corrugated board, a paper wrap or similar lightweight material only, etc. **or**
 - the outer package wall is in direct contact with the product
 - **TV/Monitor**
 - Any packaged-product which contains a TV or Monitor regardless of packaging type, dimensions or weight.

NOTE: If a packaged-product is defined as both Flat and TV/Monitor or both as Standard and TV/Monitor, in accordance with the above definitions, it should be tested as **TV/Monitor**.

OVERVIEW OF PROJECT 6-AMAZON.COM-SIOC

General

- Testing can be used to evaluate the protective performance of a packaged-product related to vibrations, shocks and other stresses normally encountered during handling and transportation in the Amazon.com distribution system.
- The package and product are considered together and not separately.
- Some conditions of transit, such as moisture, pressure, or unusual handling may not be covered.

Other ISTA Procedures or Projects may be appropriate for different conditions or to meet different objectives.

Refer to *Guidelines for Selecting and Using ISTA Test Procedures and Projects* for additional information.

NOTE:

Hazardous Material (Dangerous Goods) packaging that passes this test procedure may not meet international, national or other regulatory requirements for the transport of Hazardous Materials (Dangerous Goods). **This test is not a substitute** for United Nations and/or any other required test standards for the transport of Hazardous Materials (Dangerous Goods), but may be used as an additional test in conjunction with them.

Scope

Project 6-AMAZON.COM covers the testing of packaged-products prepared for shipment via Amazon.com's Ships In Own Container (SIOC) distribution system to North America destinations. In this system, packaged-products are typically shipped from the manufacturer or producer to an Amazon.com fulfillment center, and then to the Consumer. Various types of handling may occur in the fulfillment centers, including manual, fork lift, clamp truck, etc.

**Product Damage
Tolerance and
Package
Degradation
Allowance**

The shipper, manufacturer, Amazon.com and/or other stakeholders shall determine the following prior to testing, to permit the determination of *pass* or *fail* at the conclusion of the tests:

- what constitutes damage to the product **and**
- what damage tolerance level is allowable, if any, **and**
- the correct methodology to determine product condition at the conclusion of the test **and**
- the acceptable package condition at the conclusion of the test.

For additional information on these determinations refer to *Guidelines for Selecting and Using ISTA Test Procedures and Projects*.

**Additional
Information,
IMPORTANT**

The shipper, manufacturer, Amazon.com or other stakeholders shall also provide information regarding the initial shipment configuration, approved container loading diagram, details of shipment and configurations within the distribution system, typical atmospheric conditions, etc. as required to determine proper testing parameters.

Samples

Both products and packages should be as close as possible to actual production items. Pre-production prototypes such as hand-made samples, CAD-generated one-of-a-kind or short run samples, etc. are usually not sufficiently representative of production items to yield meaningful test results. It may be appropriate to conduct preliminary tests of a product and package early in the development cycle, but final official testing should be performed with actual production items.

For fragile items, five samples are required for this test procedure. Fragile items are defined as items that easily break or could leak during the distribution process. This includes any item containing:

- Glass / Ceramic / Porcelain / Clay
- Liquids / Semi-liquids / Solids that can become liquid at high temperatures (above 70 degrees Fahrenheit)

When multiple identical samples are tested, all samples must pass all tests.

For non-fragile items, one sample is required for this test procedure. If the sample is a palletized or a unitized load and this is the intended configuration for shipment to the end consumer, then this is constituted a single packaged-product.

TV/Monitors are considered Non-Fragile items. Establishment of a TV/Monitor test type, reduces test variability and in turn allows for greater repeatability through fewer samples.

To permit an adequate determination of representative performance of the packaged-product, ISTA:

- Requires the test procedure, with the required number of samples, to be performed one time, **but**
- Recommends performing the entire test procedure five or more times using new samples for each test.

OVERVIEW OF PROJECT 6-AMAZON.COM-SIOC

Refer to *Guidelines for Selecting and Using ISTA Test Procedures and Projects* for additional information.

Samples
(continued)

NOTE: In order to ensure testing in perfect condition, products and packages shipped to an ISTA Certified Laboratory for testing shall be:

- Adequately over-packaged for shipment **or**
- Repackaged in new packaging at the laboratory.

NOTE: Any pallet or skid used in this procedure should be of a type and condition which is typical of what is in actual field use for the packaged-product being tested.

NOTE: It is important to thoroughly document the configuration, materials, and construction of the tested product and package. Significant variations in performance can sometimes be caused by seemingly insignificant differences. Photo documentation is strongly recommended to supplement detailed written descriptions.

The tests shall be performed on each test sample in the sequence indicated in the following tables:

Type A - Parcel Delivery of Individual Packaged-Products Less Than 50 lb (23 kg)

Test Sequence
Type A

Parcel Delivery
of Individual
Packaged-
Products
Less Than
50 lb (23 kg)

Sequence Number	Test Category	Test Type	Test Level	Remarks
1	Atmospheric Preconditioning TEST BLOCK 1	Temperature and Humidity	Lab ambient, 12 hours	Required
2	Atmospheric Conditioning TEST BLOCK 1	Controlled Temperature and Humidity	Temperature and humidity chosen from chart	Optional
3	Shock TEST BLOCK 2	Free-Fall Drop	9 Drops - height varies with packaged-product weight	Required
4	Vibration TEST BLOCK 12	Random With and Without Top Load	Overall Grms levels of 0.53 and 0.46	Required
5	Shock TEST BLOCK 15	Free-Fall Drop	8 Drops - height varies with packaged-product weight. Includes drop on hazard	Required
6	Shock TEST BLOCK 21	Rotational Edge Drop	9 in (230 mm)	Required for Elongated and Flat Packages
7	Shock TEST BLOCK 22	Full Rotational Flat Drop	Varies with packaged-product dimensions	Required for Elongated and Flat Packages
8	Shock TEST BLOCK 23	Bridge Impact	Hazard Box dropped 16 in (400 mm)	Required for Elongated Packages Only
9	Shock TEST BLOCK 24	Concentrated Edge Impact	Hazard Box dropped 16 in (400 mm)	Required for Flat Packages Only
10	Integrity TEST BLOCK 25	Leak Test	8 hours	Required for Liquids ONLY

OVERVIEW OF PROJECT 6-AMAZON.COM-SIOC

Type B - Parcel Delivery of Individual Packaged-Products 50 lb (23 kg) to Less Than 100 lb (45 kg)

Test Sequence
Type BParcel Delivery
of Individual
Packaged-
Products
50 lb (23 kg) to
Less Than
100 lb (45 kg)

Sequence Number	Test Category	Test Type	Test Level	Remarks
1	Atmospheric Preconditioning TEST BLOCK 1	Temperature and Humidity	Lab ambient, 12 hours	Required
2	Atmospheric Conditioning TEST BLOCK 1	Controlled Temperature and Humidity	Temperature and humidity chosen from table	Optional
3	Shock TEST BLOCK 2	Free-Fall Drop	9 Drops - height varies with packaged-product weight	Required
4	Shock TEST BLOCK 3	Tip/Tip Over	Use a 22 degree tip angle	Required for packages ≥ 48 in. (1.2 m) tall and any one base dimension $< \frac{1}{2}$ the height; or for packages ≥ 30 in. (760 mm) tall and with a center of gravity vertical location $> \frac{1}{2}$ the package height
5	Compression, Horizontal TEST BLOCK 9	Clamping Simulation	Calculated from formula Clamp in multiple orientations as directed	Required For any of the 2 axes with a width dimension ≥ 24 in (610mm) and < 75 in (1905 mm)
6	Compression, Vertical TEST BLOCK 10	Test in the intended shipping orientation or most stable orientation	Calculated from formula Maintain force for 1 hour	Required Machine, or weights & load spreader
7	Vibration TEST BLOCK 12	Random With and Without Top Load	Overall Grms levels of 0.53 and 0.46	Required
8	Shock TEST BLOCK 15	Free-Fall Drop	8 Drops - height varies with packaged-product weight. Includes drop on hazard	Required
9	Shock TEST BLOCK 21	Rotational Edge Drop	9 in (230 mm)	Required for Elongated and Packages
10	Shock TEST BLOCK 22	Full Rotational Flat Drop	Varies with packaged-product dimensions	Required for Elongated and Flat Packages
11	Shock TEST BLOCK 23	Bridge Impact	Hazard Box dropped 16 in (400 mm)	Required for Elongated Packages Only
12	Shock TEST BLOCK 24	Concentrated Edge Impact	Hazard Box dropped 16 in (400 mm)	Required for Flat Packages Only
13	Integrity TEST BLOCK 25	Leak Test	8 hours	Required for Liquids ONLY

OVERVIEW OF PROJECT 6-AMAZON.COM-SIOC

Type C - Parcel Delivery of Individual Packaged-Products 100 lb (45 kg) or Greater

Note: Parcel Delivery has a weight limitation of 150 lb (68 kg)Test Sequence
Type CParcel Delivery
of Individual
Packaged-
Products
100 lb (45 kg)
or Greater

Sequence Number	Test Category	Test Type	Test Level	Remarks
1	Atmospheric Preconditioning TEST BLOCK 1	Temperature and Humidity	Lab ambient, 12 hours	Required
2	Atmospheric Conditioning TEST BLOCK 1	Controlled Temperature and Humidity	Temperature and humidity chosen from chart	Optional
3	Shock TEST BLOCK 3	Tip/Tip Over	Use a 22 degree tip angle	Required for packages ≥ 48 in. (1.2 m) tall and any one base dimension $< \frac{1}{2}$ the height; or for packages ≥ 30 in. (760 mm) tall and with a center of gravity vertical location $> \frac{1}{2}$ the package height
4	Shock TEST BLOCK 5	Rotational FLAT Drop	9 in (230 mm)	Required
5	Shock TEST BLOCK 6	Rotational EDGE Drop	9 in (230 mm)	Required
6	Shock TEST BLOCK 8	Inclined or Horizontal Impact	48 in/sec (4 ft/sec) (1.2 m/sec) impact velocity or velocity change	Required
7	Compression, Horizontal TEST BLOCK 9	Clamping Simulation	Calculated from formula Clamp in multiple orientations as directed	Required For any of the 2 axes with a width dimension ≥ 24 in (610mm) and < 75 in (1905 mm)
8	Compression, Vertical TEST BLOCK 10	Test in the intended shipping orientation or most stable orientation	Calculated from formula Maintain force for 1 hour	Required Machine, or weights & load spreader
9	Vibration TEST BLOCK 12	Random With and Without Top Load	Overall Grms levels of 0.53 and 0.46	Required
10	Shock TEST BLOCK 20	Inclined or Horizontal Impact	48 in/sec (4 ft/sec) (1.2 m/sec) impact velocity or velocity change	Required
11	Shock TEST BLOCK 21	Rotational Edge Drop	9 in (230 mm)	Required for Elongated and Flat Packages
12	Shock TEST BLOCK 22	Full Rotational Flat Drop	Varies with packaged-product dimensions	Required for Elongated and Flat Packages
13	Shock TEST BLOCK 23	Bridge Impact	Hazard Box dropped 16 in (400 mm)	Required for Elongated Packages Only
14	Shock TEST BLOCK 24	Concentrated Edge Impact	Hazard Box dropped 16 in (400 mm)	Required for Flat Packages Only

OVERVIEW OF PROJECT 6-AMAZON.COM-SIOC

Type D - LTL Delivery of Individual Packaged-Products Less Than 100 lb (45 kg)

Test Sequence
Type DLTL Delivery
of Individual
Packaged-
Products
Less Than
100 lb (45 kg)

Sequence Number	Test Category	Test Type	Test Level	Remarks
1	Atmospheric Preconditioning TEST BLOCK 1	Temperature and Humidity	Lab ambient, 12 hours	Required
2	Atmospheric Conditioning TEST BLOCK 1	Controlled Temperature and Humidity	Temperature and humidity chosen from table	Optional
3	Shock TEST BLOCK 3	Tip/Tip Over	Use a 22 degree tip angle	Required for packages ≥ 48 in. (1.2 m) tall and any one base dimension $< \frac{1}{2}$ the height; <u>or</u> for packages ≥ 30 in. (760 mm) tall and with a center of gravity vertical location $> \frac{1}{2}$ the package height
4	Shock TEST BLOCK 4	Free-Fall Drop	6 drops – 18 in (460 mm) max	Required
Δ 5	Compression, Horizontal TEST BLOCK 9	Clamping Simulation	Calculated from formula Clamp in multiple orientations as directed	Required For any of the 2 axes with a width dimension ≥ 24 in (610mm) and < 75 in (1905 mm)
Δ 6	Compression, Vertical TEST BLOCK 10	Test in the intended shipping orientation or most stable orientation	Calculated from formula Maintain force for 1 hour	Required Machine, or weights & load spreader
7	Vertical Vibration TEST BLOCK 13	Random With Top Load	Overall Grms level of 0.54	Required
8	Shock TEST BLOCK 16	Free-Fall Drop	6 drops – 32 in (810 mm) max	Required
9	Shock TEST BLOCK 22	Full Rotational Flat Drop	Varies with packaged-product dimensions	Required for Elongated and Flat Packages
10	Shock TEST BLOCK 23	Bridge Impact	Hazard Box dropped 16 in (400 mm)	Required for Elongated Packages Only
11	Shock TEST BLOCK 24	Concentrated Edge Impact	Hazard Box dropped 16 in (400 mm)	Required for Flat Packages Only

OVERVIEW OF PROJECT 6-AMAZON.COM-SIOC

Type E - LTL Delivery of Individual Packaged-Products 100 lb (45 kg) or Greater

Test Sequence
Type ELTL Delivery
of Individual
Packaged-
Products
100 lb (45 kg)
or Greater

Sequence Number	Test Category	Test Type	Test Level	Remarks
1	Atmospheric Preconditioning TEST BLOCK 1	Temperature and Humidity	Lab ambient, 12 hours	Required
2	Atmospheric Conditioning TEST BLOCK 1	Controlled Temperature and Humidity	Temperature and humidity chosen from table	Optional
3	Shock TEST BLOCK 3	Tip/Tip Over	Use a 22 degree tip angle	Required for packages ≥ 48 in. (1.2 m) tall and any one base dimension $< \frac{1}{2}$ the height; or for packages ≥ 30 in. (760 mm) tall and with a center of gravity vertical location $> \frac{1}{2}$ the package height
4	Shock TEST BLOCK 5	Rotational FLAT Drop	9 in (230 mm)	Required
5	Shock TEST BLOCK 6	Rotational EDGE Drop	9 in (230 mm)	Required
6	Shock TEST BLOCK 8	Inclined or Horizontal Impact	48 in/sec (4 ft/sec) (1.2 m/sec) impact velocity or velocity change	Required
7	Compression, Horizontal TEST BLOCK 9	Clamping Simulation	Calculated from formula Clamp in multiple orientations as directed	Required For any of the 2 axes with a width dimension ≥ 24 in (610mm) and < 75 in (1905 mm)
8	Compression, Vertical TEST BLOCK 10	Test in the intended shipping orientation or most stable orientation	Calculated from formula Maintain force for 1 hour	Required Machine, or weights & load spreader
9	Vertical Vibration TEST BLOCK 13	Random With Top Load	Overall Grms level of 0.54	Required
10	Shock TEST BLOCK 20	Inclined or Horizontal Impact	48 in/sec (4 ft/sec) (1.2 m/sec) impact velocity or velocity change	Required
11	Shock TEST BLOCK 23	Bridge Impact	Hazard Box dropped 16 in (400 mm)	Required for Elongated Packages Only
12	Shock TEST BLOCK 24	Concentrated Edge Impact	Hazard Box dropped 16 in (400 mm)	Required for Flat Packages Only

OVERVIEW OF PROJECT 6-AMAZON.COM-SIOC

Type F - LTL Delivery of Individual Palletized Packaged-Products

Test Sequence
Type FLTL Delivery
of Individual
Palletized
Packaged-
Products

Sequence Number	Test Category	Test Type	Test Level	Remarks
1	Atmospheric Preconditioning TEST BLOCK 1	Temperature and Humidity	Lab ambient, 12 hours	Required
2	Atmospheric Conditioning TEST BLOCK 1	Controlled Temperature and Humidity	Temperature and humidity chosen from chart	Optional
3	Shock TEST BLOCK 3	Tip/Tip Over	Use a 22 degree tip angle	Required for packages ≥ 48 in. (1.2 m) tall and any one base dimension $< \frac{1}{2}$ the height; or for packages ≥ 30 in. (760 mm) tall and with a center of gravity vertical location $> \frac{1}{2}$ the package height
4	Shock TEST BLOCK 5	Rotational FLAT Drop	9 in (230 mm)	Required
5	Shock TEST BLOCK 6	Rotational EDGE Drop	9 in (230 mm)	Required
6	Shock TEST BLOCK 7	Rotational CORNER Drop	9 in (230 mm)	Required
7	Shock TEST BLOCK 8	Inclined or Horizontal Impact	48 in/sec (4 ft/sec) (1.2 m/sec) impact velocity or velocity change	Required
8	Compression, Vertical TEST BLOCK 10	Top-to-Bottom Pallet on top	Calculated from formula	Required Machine or weights and load spreader
9	Shock TEST BLOCK 11	Fork Lift Simulation	Flat Push and Rotate tests, Elevated Push and Pull tests	Required
10	Vertical Vibration TEST BLOCK 14	Random With Top Load	Overall Grms level of 0.54	Required
11	Shock TEST BLOCK 17	Rotational FLAT Drop	9 in (230 mm)	Required
12	Shock TEST BLOCK 18	Rotational EDGE Drop	9 in (230 mm)	Required
13	Shock TEST BLOCK 19	Rotational CORNER Drop	9 in (230 mm)	Required
14	Shock TEST BLOCK 20	Inclined or Horizontal Impact	48 in/sec (4 ft/sec) (1.2 m/sec) impact velocity or velocity change	Required
15	Shock TEST BLOCK 24	Concentrated Edge Impact	Hazard box dropped 16 in (410 mm)	Required for Flat Packages Only

OVERVIEW OF PROJECT 6-AMAZON.COM-SIOC

Type G – Parcel Delivery of Individual Packaged TV/Monitor Less Than 150 lbs (68 kg) AND

Girth Less Than 165 inch (4.19 m)

Test Sequence
Type GParcel Delivery
TV/Monitor
Less Than 150 lb
(68 kg)
AND
Girth Less Than
165 in (4.19 m)

O

Note: Girth is a measurement of the packaged-product Length + 2 * (Width + Height). See Preface for more information.

Sequence Number	Test Category	Test Type	Test Level	Remarks
1	Atmospheric Preconditioning TEST BLOCK 1	Temperature and Humidity	Lab ambient, 12 hours	Required
2	Atmospheric Conditioning TEST BLOCK 1	Controlled Temperature and Humidity	Temperature and humidity chosen from table	Optional
3	Shock TEST BLOCK 2	Free-Fall Drop	9 Drops - height varies with packaged-product weight	Required- Do not catch packaged items
4	Compression, Horizontal TEST BLOCK 9	Clamping Simulation	Calculated from formula Clamp in multiple orientations as directed	Required For any of the 2 axes with a width dimension ≥ 24 in (610mm) and < 75 in (1905 mm)
5	Compression, Vertical TEST BLOCK 10	Test in the intended shipping orientation	Calculated from formula Maintain force for 1 hour	Required Machine, or weights & load spreader
6	Vibration TEST BLOCK 12	Random With and Without Top Load	Overall Grms levels of 0.53 and 0.46	Required
7	Shock TEST BLOCK 20	Inclined or Horizontal Impact	48 in/sec (4 ft/sec) (1.2 m/sec) impact velocity or velocity change	Required for packages ≥ 100 lbs (45 kg)
8	Shock TEST BLOCK 15	Free-Fall Drop	8 Drops - height varies with packaged-product weight. Includes drop on hazard	Required- Do not catch packaged items
9	Shock TEST BLOCK 24	Concentrated Edge Impact	Hazard Box dropped 16 in (400 mm)	Required

OVERVIEW OF PROJECT 6-AMAZON.COM-SIOC

Type H – LTL Delivery of Individual Packaged TV/Monitor Greater Than 150 lbs (68 kg) OR Girth Greater Than 165 inch (4.19 m)

Note: Girth is a measurement of the packaged-product Length + 2 * (Width + Height). See Preface for more information

Test Sequence
Type H

LTL Delivery
TV/Monitor
Greater Than 150 lb
(68 kg)
OR
Girth Greater Than
165 in (4.19 m)

Sequence Number	Test Category	Test Type	Test Level	Remarks
1	Atmospheric Preconditioning TEST BLOCK 1	Temperature and Humidity	Lab ambient, 12 hours	Required
2	Atmospheric Conditioning TEST BLOCK 1	Controlled Temperature and Humidity	Temperature and humidity chosen from table	Optional
3	Shock TEST BLOCK 3	Tip/Tip Over	Use a 22 degree tip angle	Required for packages ≥48 in. (1.2 m) tall and any one base dimension < ½ the height; or for packages ≥ 30 in. (760 mm) tall and with a center of gravity vertical location > ½ the package height
4	Shock TEST BLOCK 4	Free-Fall Drop	6 drops – 18 in (460 mm) max	Required for packages =< 100 lbs (45 kg) - Do not catch packaged items
5	Shock TEST BLOCK 5	Rotational FLAT Drop	9 in (230 mm)	Required
6	Shock TEST BLOCK 6	Rotational EDGE Drop	9 in (230 mm)	Required
7	Shock TEST BLOCK 8	Inclined or Horizontal Impact	48 in/sec (4 ft/sec) (1.2 m/sec) impact velocity or velocity change	Required for packages >= 100 lbs (45 kg)
8	Compression, Horizontal TEST BLOCK 9	Clamping Simulation	Calculated from formula Clamp in multiple orientations as directed	Required For any of the 2 axes with a width dimension ≥ 24 in (610mm) and < 75 in (1905 mm)
9	Compression, Vertical TEST BLOCK 10	Test in the intended shipping orientation	Calculated from formula Maintain force for 1 hour	Required Machine, or weights & load spreader
10	Vertical Vibration TEST BLOCK 13	Random With Top Load	Overall Grms level of 0.54	Required
11	Shock TEST BLOCK 16	Free-Fall Drop	6 drops – 32 in (810 mm) max	Required for packages =< 100 lbs (45 kg) - Do not catch packaged items
10	Shock TEST BLOCK 20	Inclined or Horizontal Impact	48 in/sec (4 ft/sec) (1.2 m/sec) impact velocity or velocity change	Required for packages >= 100 lbs (45 kg)
12	Shock TEST BLOCK 22	Full Rotational Flat Drop	Varies with packaged-product dimensions	Required
13	Shock TEST BLOCK 24	Concentrated Edge Impact	Hazard Box dropped 16 in (400 mm)	Required- Hazard Box to be dropped to the screen side

EQUIPMENT REQUIRED FOR PROJECT 6-AMAZON.COM-SIOC

Equipment
Required
Atmospheric
Conditioning



Atmospheric Pre-Conditioning and Conditioning:

- Humidity recorder complying with of the apparatus section of ASTM D 4332 or ISO 2233.
- Temperature recorder complying with the apparatus section of ASTM D 4332 or ISO 2233.

Controlled Temperature and Humidity:

- Chamber and Control apparatus complying with the apparatus section of ASTM D 4332 or ISO 2233.

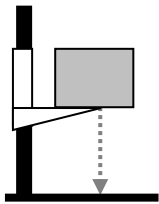
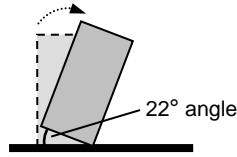
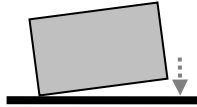
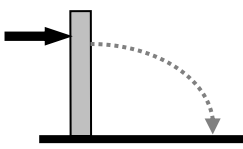
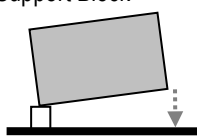
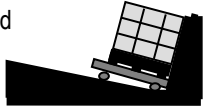
Equipment
Required
Shock

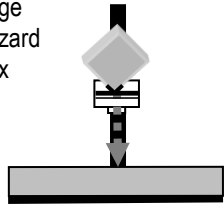
Type of Shock Test	Type of Equipment	Equipment Requirements	Additional Required Equipment
Free-Fall Drop Tests	Free-fall drop tester 	Compliance with the apparatus sections of ASTM D 5276 or ISO 2248.	
Tip/Tipover Tests	 22° angle	ASTM D 6179 or ISO 2876	
Rotational Flat Drop Tests		Compliance with the apparatus sections of ASTM D 6179 or ISO 2876.	
Full Rotational Drops		ASTM D 6179 or ISO 2876	
Rotational Edge and Corner Drop Tests	Support Block 	Compliance with the apparatus sections of ASTM D 6179 or ISO 2876.	Support block 3.5 to 4.0 in (90 to 100 mm) in height and width and at least 8 in (200 mm) longer than the longest package dimension to be supported.
Inclined or Horizontal Impact Tests (Alternates)	Inclined  Horizontal 	Compliance with the apparatus sections of ASTM D 880 or ASTM D 4003 or ISO 2244.	
Concentrated Edge Impact Tests	Free-fall drop tester with edge hazard box 	Drop tester in compliance with the apparatus sections of ASTM D 5276 or ISO 2248.	Concentrated Edge Hazard Box 12 x 12 x 12 in (305 x 305 x 305 mm) wood box with a total weight of 9 lb (4.1 kg). Any required ballast weight should be dense flowable material in a bag or bags, held in place with suitable void fill. The impact edge of the box shall be covered with angle iron.

EQUIPMENT REQUIRED FOR PROJECT 6-AMAZON.COM-SIOC

Equipment
Required
Shock
(continued)

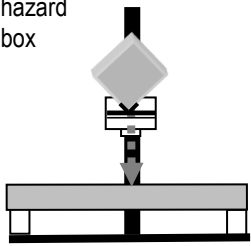
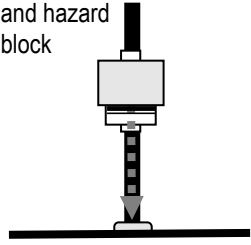
Bridge Impact Tests	Free-fall drop tester with edge hazard box 	Compliance with the apparatus section of ASTM D 5265, with the exception of the Hazard Box (Impactor).	Concentrated Edge Hazard Box and Support Blocks See above for description of the Concentrated Edge Hazard Box. Support blocks (2 ea) shall be 3.5 to 4.0 in (90 to 100 mm) in height and width and at least 8 in (200 mm) longer than the longest package dimension to be supported.
Drop Onto Hazard	Free-fall drop tester and hazard block 		Hazard Block See below.

Hazard Block

The block shall be made of hardwood or metal. The height shall be to 1 in (20 to 25 mm) and the width shall be 6 in (150 mm). The length be at least 8 in (200 mm) longer than the longest package dimension will impact. The long top edges of the block shall be rounded to a radius equal to the height of the block.

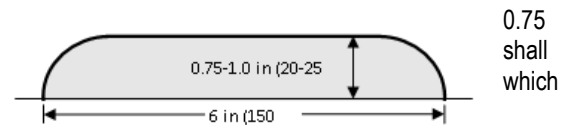

Equipment
Required
Compression

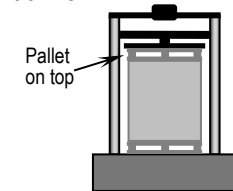
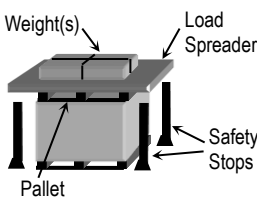
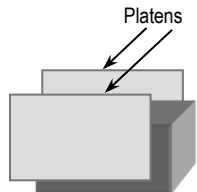
Type of Compression Test	Type of Equipment	Equipment Requirements	Additional Required Equipment
Vertical Compression (Top-to-Bottom)	Compression Test Machine 	Compliance with the apparatus section of ASTM D 642 - Fixed or Swivel Platen Acceptable.	If test item is shipped on a pallet (standard or custom), use an identical pallet on top.
Vertical Compression (Top-to-Bottom) (Alternate)	Weight(s) & Load Spreader 	The Load spreader must be larger than the top face of the test item, and shall be sufficiently rigid to apply a uniform compression force.	If test item is shipped on a pallet (standard or custom), use an identical pallet on top. Safety stops are recommended to support the load spreader and weight(s) to prevent damage or injury in the event of a rapid collapse of the test item.
Horizontal Compression (Clamping Simulation)	Clamp Tester 	Platens must be larger than the side dimensions of the test item, and with an opening sufficient to accommodate the test item. The desired compression must be achieved with minimum overshoot.	Controls must permit applying the required clamping force at a consistent rate and the ability to raise the test item a minimum of 12" (305 mm). Force measurement accuracy to within $\pm 5\%$ of the actual value, using accepted calibration means.

Δ - Most recent technical change(s)

○ - Most recent technical addition(s)

EQUIPMENT REQUIRED FOR PROJECT 6-AMAZON.COM-SIOC

Equipment
Required
Horizontal
Compression
(Continued)

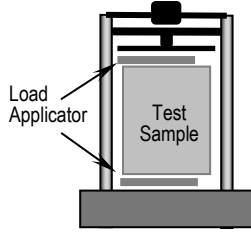
Type of Vibration Test	Type of Equipment	Equipment Requirements	Additional Required Equipment
Horizontal Compression (Clamping Simulation) (Alternative)	Compression Test Machine 	Compliance with the apparatus section of ASTM D 642 - Fixed Platen Only.	Rigid load applicator (such as a 3/4" {19 mm} piece of plywood or a plate of steel) that is larger than the test sample face to be tested on the compression test machine.

O

Equipment
Required
Vertical
Vibration

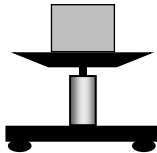
Type of Vibration Test	Type of Equipment	Equipment Requirements	Additional Required Equipment
Vertical Vibration	Random Vibration Test System 	Compliance with the apparatus section of ASTM D 4728 or ISO 13355	Means must be provided to maintain proper alignment of the test item and any top load apparatus, and to prevent the test item from moving off the vibration system's platform, without restricting vertical motion of the test item or apparatus.

Equipment
Required
Flat Push

Type of Test	Type of Equipment	Equipment Requirements	Additional Required Equipment
Fork Lift Handling	Fork Lift Truck 	A fork lift truck of sufficient capacity to handle the test specimens and complying with the apparatus sections of ASTM D 6055 or ISO 10531.	

Equipment
Required
Additional

Vibration
Top Load
Apparatus for
Type A, Type B,
Type C, & Type G
Packaged-
Products

The **Top Load Apparatus** required for the vibration testing of **Type A, Type B, Type C and Type G** packaged-products is detailed below

- A fiberboard box, or other container, of sufficient strength and ability to hold a load spreader (such as a 3/4" piece of plywood or a plate of steel that is the same length and width as the inside dimensions of the load apparatus) and required weight for each axis **and**
- The length and width dimensions of the Top-Load package or apparatus which will be applied to the test specimen shall each be a minimum of 50 mm (2 in) longer than each of the two dimensions of the test specimen's top face when positioned for testing [i.e., a minimum of 25 mm (1 in) overhang on each side] **but**
- The length and width dimensions of the Top-Load package or apparatus may each be longer by a maximum of 150 mm (6 in) than each of the two dimensions of the test specimen's top face when positioned for testing [i.e., a maximum of 75 mm (3 in) overhang on each side] **and**
- Some means of adding additional weight so that the Top-Load (TL) is distributed evenly over the entire inside face area of the Top-Load apparatus that will apply the Top-Load to the entire top face of the test specimen when it's positioned for testing **and**
- Adequate void fill that shall securely hold the weight in place to prevent the weight from moving or bouncing within the top-load apparatus (it is also required to use stretch wrap around the test specimen and the top-load apparatus to prevent the top-load apparatus from bouncing on top of the test specimen) **and**
- The top-load apparatus shall never be smaller than the test face; the calculated weight must cover the entire surface of the test face during the testing.

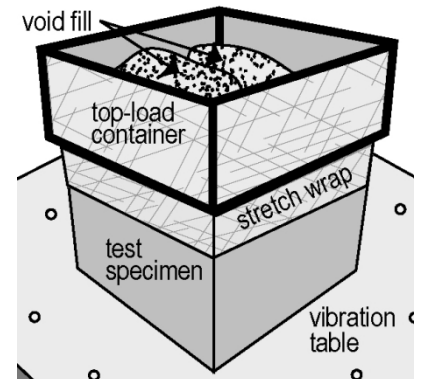

The **Top Load Apparatus** required for the vibration testing of **Type D, Type E, Type F and Type H** packaged-products is detailed below

- The **Top Load Apparatus** is described and shown below, and includes:
 - A sturdy fiberboard box or similar container with a height of 9 in (230 mm), and with a minimum 0.75 in (20 mm) thick plywood load spreader covering the entire inside bottom surface.
 - Some means of adding additional weight as required so that the top load is distributed evenly over the entire inside bottom face area of the top load apparatus.
 - Adequate void fill to securely hold the weight in place to prevent it from moving or bouncing within the top load apparatus.
 - Bottom face dimensions (length and width) which are at least 2 in (50 mm) larger than the top face dimensions of the test item to which it is applied [for a minimum overhang of 1 in (25 mm) on each side], but must not be greater than 6 in (150 mm) larger than the top face dimensions of the test item [for a maximum of 3 in (76 mm) overhang on each side].
- The **Top Load Apparatus** must be divided into 2 separate equal portions if one of the top face dimensions of the test item exceeds 18 in (460 mm), and into 4 separate equal portions if both of the top face dimensions of the test item exceed 18 in (460 mm).

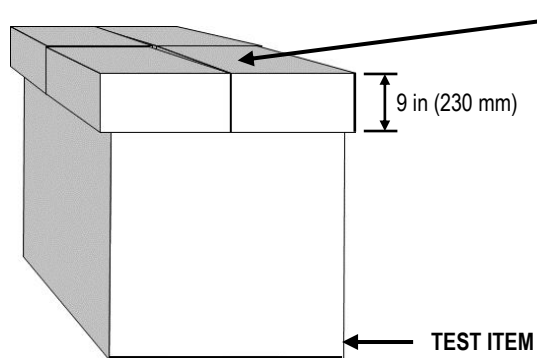

- Use an undivided apparatus if both top face dimensions of the test item are 18 in (460 mm) or less.
- Divide the apparatus into two separate equal portions if one top face dimension of the test item exceeds 18 in (460 mm). Divide the apparatus perpendicular to the longest dimension.
- Divide the apparatus into four separate equal portions if both top face dimensions of the test item exceed 18 in (460 mm).

The Top Load is to simulate the effects of 6 lb/ft³ (0.0035 lb/in³) (96 kg/m³) of assorted freight on top of a Floor-Loaded packaged-product in a truck-trailer or ocean container with an inside height of 108 in (2.7 m). This load density has been determined by empirical testing which resulted in correlation between damage in the test lab and damage in the field.

- Means must be provided to maintain proper alignment of the Top Load Apparatus on the test item (column stack fixtures, stretch wrap around the test specimen and the top load apparatus, etc.), without restricting the vertical motion of the top load apparatus and the test specimen.

BEFORE YOU BEGIN PROJECT 6-AMAZON.COM-SIOC

Prior to beginning the tests, identify the faces, edges and corners (or other members) of the test specimen according to the procedure below.

Identification of
Faces, Edges
and Corners
(Test Specimen
Members)

Step	Action	
1	IF the packaged-product type is ...	THEN go to...
	Type A , Parcel Delivery of Individual Packaged-Products Less Than 50 lb (23 kg) or Type B , Parcel Delivery of Individual Packaged-Products 50 lb (23 kg) to Less Than 100 lb (45 kg) or Type C , Parcel Delivery of Individual Packaged-Products 100 lb (45 kg) or Greater Type G , Parcel Delivery of TV/Monitor with Weight Less Than 150 lb (68 kg) and Girth Less Than 165 inch (length+ 2*(W+H))	Step 2 of this TEST BLOCK.
	Type D , LTL Delivery of Individual Packaged-Products Less Than 100 lb (45 kg) or Type E , LTL Delivery of Individual Packaged-Products 100 lb (45 kg) or Greater Type H , LTL Delivery of TV/Monitor with Weight 150 lbs (68 kg) or Greater or Girth Greater Than 165 inch (length+ 2*(W+H))	Step 3 of this TEST BLOCK.
	Type F , LTL Delivery of Individual Palletized Packaged-Products	Step 4 of this TEST BLOCK
2	<p>Place the packaged-product in its most stable orientation.</p> <ul style="list-style-type: none"> Place the packaged-product in its <i>most stable</i> orientation. <i>Most stable</i> is generally with one of the largest faces down, unless a center of gravity offset or an unusual package configuration causes some other orientation to be most stable. For Flat and Elongated packaged-products, place the item with one of the largest faces down. For TV/Monitors, Place the screen side down. <p>Document the packaged-product orientation and the identification of Faces, Edges, and Corners (Test Specimen Numbers) on the Test Report. Go to Step 5.</p>	
3	<p>Place the packaged-product in its intended shipping orientation, or in its most stable orientation.</p> <ul style="list-style-type: none"> If the packaged-product has markings or labels which specify a particular shipping orientation, or a configuration which specifies a particular shipping orientation, or has a single particular shipping orientation indicated by an approved container loading diagram, place it in that orientation. Otherwise, place the packaged-product in its <i>most stable</i> orientation. <i>Most stable</i> is generally with one of the largest faces down, unless a center of gravity offset or an unusual package configuration causes some other orientation to be most stable. For Flat and Elongated packaged-products, place the item with one of the largest faces down. For TV/Monitors, Place packaged-product in its intended shipping orientation so that the screen side of the sample will be Face 4. <p>Document the packaged-product orientation and the identification of Faces, Edges, and Corners (Test Specimen Numbers) on the Test Report. Go to Step 5.</p>	
4	<p>Place the palletized packaged-product in its normal handling and shipping orientation.</p> <p>Go to Step 5.</p>	
5	IF the test specimen is ...	THEN...
	Any type of packaged-product with only six faces (2 sides, 2 ends, top and bottom)	Turn the packaged-product so that one of the smallest faces is directly in front of you. Go to Step 6.
	Any type of packaged-product with less than or more than six faces	Develop a method to identify each face, edge and corner or other members and document with a diagram. Go to Step 6.

Continued from previous page

Identification of
Faces, Edges
and Corners
(Test Specimen
Members)
(continued)

6

- Identify faces according to the diagrams.
- Identify edges using the numbers of the two faces forming that edge. Example: Edge 1-2 is the edge formed by face 1 and face 2 of the packaged-product.
- Identify corners using the numbers of the three faces that meet to form that corner. Example: Corner 2-3-5 is the corner formed by face 2, face 3, and face 5 of the packaged-product.
- Identify orientation of the product inside the package.

Unitized Load on Standard or Custom Pallet

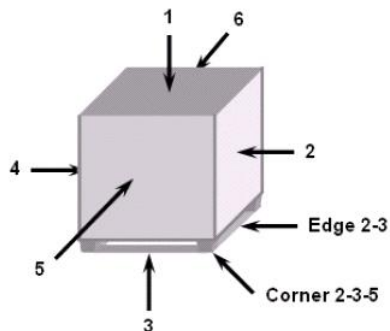

Individual Unit or Case

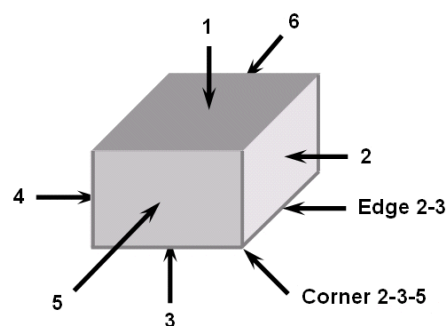

Flat

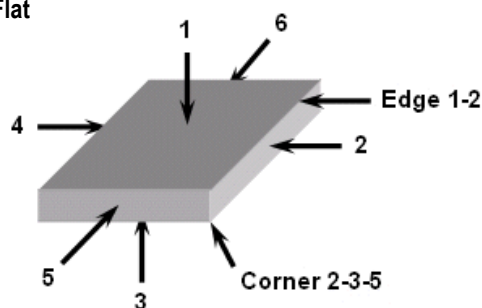

Elongated

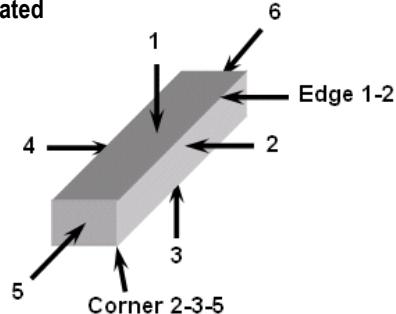

TV/Monitor Face Numbering - Parcel

- Face 1:** Back of TV/Monitor
- Face 2:** Bottom of TV/Monitor
- Face 3:** Screen of TV/Monitor
- Face 4:** Top of TV/Monitor
- Face 5:** Always on Right When Looking at Face 3
- Face 6:** Always on Left When Looking at Face 3

TV/Monitor Face Numbering - LTL

- Face 1:** Top of TV/Monitor
- Face 2:** Back of TV/Monitor
- Face 3:** Bottom of TV/Monitor
- Face 4:** Screen of TV/Monitor
- Face 5:** Always on Right When Looking at Face 4
- Face 6:** Always on Left When Looking at Face 4

- **Parcel:** Place in most stable position
 - TVs lay down, screen face down

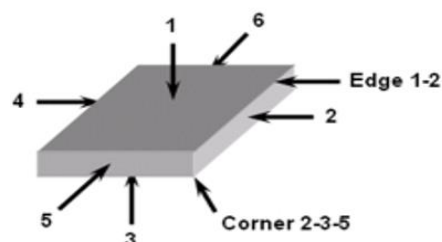

- **LTL:** Place in intended shipping orientation

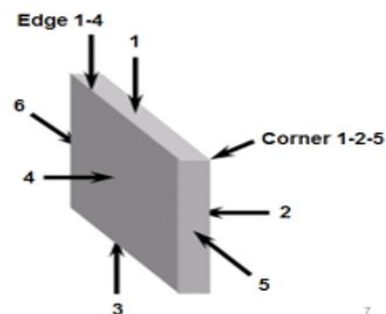

BEFORE YOU BEGIN PROJECT 6-AMAZON.COM-SIOC

The weight and size of the packaged-product shall be determined:

- Gross weight in pounds (lb) for English units and kilograms (kg) for Metric
- Exterior dimensions of Length, Width and Height (L x W x H) in inches (in) for English units and millimeters (mm) or meters (m) for Metric.

Required Preconditioning:

The packaged-product shall be preconditioned to laboratory ambient temperature and humidity for not less than twelve (12) hours prior to testing where specified.

Optional Conditioning (to be performed after the required preconditioning):

To permit an adequate determination of packaged-product performance at anticipated atmospheric limits and where it is known that the atmospheric extremes are detrimental to the product or package, ISTA:

- **Requires** the highest temperature and humidity limits of the product be used, **but**
- **Recommends** that both the highest and lowest atmospheric conditions be used.

Condition packaged-products according to one or more of the conditions listed in the table below. The best approach is to perform all tests directly in the conditioned atmosphere. If this is not possible, then tests should be performed quickly after removal of test items from the conditioned atmosphere.

If more than one conditioning sequence is selected, a new and complete test should be performed following each condition.

Optional Conditions	Time in Hours	Temperature in °C ±2°C (°F ±4°F)	Humidity in %
Extreme Cold, Uncontrolled RH	72	-29°C (-20°F)	Uncontrolled RH
Cold, Humid	72	5°C (40°F)	85% RH ± 5%
Controlled Conditions	72	23°C (73°F)	50% RH ± 5%
Hot, Humid	72	38°C (100°F)	85% RH ± 5%
Hot, Humid THEN Extreme Heat, Moderate RH	72 & 6	38°C (100°F) THEN 60°C (140°F)	85% RH ± 5% THEN 30% RH ± 5%
Elevated Temperature, Uncontrolled RH	72	50°C (120°F)	Uncontrolled RH
Extreme Heat, Dry	72	60°C (140°F)	15% RH ± 5%
Severe Cold, Uncontrolled RH	72	-18°C (0°F)	Uncontrolled RH
User Defined High Limit	72	Based upon known conditions	Known conditions
User Defined Low Limit	72	Based upon known conditions	Known conditions
User Defined Cycle	72	Based upon known conditions	Known conditions

Rotational Drop Tests for Packaged-Products

In the TEST BLOCKS, rotational flat drops and rotational edge drops for packaged-products are required. In some orientations these types of drops are not possible due to packaged-product configuration, dimensions, or other reasons. If a packaged-product in a particular orientation topples over before a side or edge can be lifted to the required drop height, then the rotational drop is not possible. This may particularly be the situation for Flat and Elongated packaged-products in small-face-down orientations, but may occur for other configurations as well. Rotational flat and edge drops for packaged-products are not required in orientations where such drops are not possible.

Inclined or Horizontal Impacts

- The required impact tests may be accomplished with either an inclined or horizontal machine. If an inclined-impact machine is used, the minimum required *impact velocity* must be 48 in/sec (4.0 ft/sec) (1.2 m/sec). If a horizontal-impact machine is used, the minimum required *velocity change* must be 48 in/sec (4.0 ft/sec) (1.2 m/sec) and the required shock must be a nominal 10 millisecond half sine pulse.
- If any velocity of an impact test is below the required minimum, that test must be repeated until velocity meets the minimum.

BEFORE YOU BEGIN PROJECT 6-AMAZON.COM-SIOC

Before You Begin Vertical Compression Testing

Overview:

Vertical (top-to-bottom) compression tests are required for all packaged-product types covered by this project except Type A. Formulas are used to calculate the compression test values.

Either a compression machine or a system of weight(s) and a load spreader may be used for these tests.

CAUTION:

When using weight(s) and a load spreader use extreme care to prevent injury. The use of safety stops is recommended to support the load spreader and weight(s) to prevent damage or injury in the event of a rapid collapse of the test item.

VERTICAL COMPRESSION TEST FORCE/WEIGHT DETERMINATION							
Step	Action						
1	Position the packaged-product in its intended shipping orientation; if the intended shipping orientation is unknown, place the packaged-product in its most stable orientation.						
2	<p>Calculate vertical compression values from the formulas given in this Step.</p> <p>Formula definitions:</p> <p>H = max stack height. If max stack height is clearly printed on the packaged-product then use that as "H." If max stack height is not indicated on the packaged-product then use 144 in (3658 mm). "H" to not exceed 144 in (3658 mm).</p> <p>V = vertical dimension of packaged-product when placed in its appropriate orientation (in) (mm)</p> <p>Wt = weight of test item (lbs) (kg)</p> <p>M = compensating factor (use 3.0 for all)</p> <table border="1"> <thead> <tr> <th>IF testing will be performed with...</th> <th>THEN... Use the appropriate formula below to calculate the required compression test force or the total required compression test weight.</th> </tr> </thead> <tbody> <tr> <td>A compression testing machine</td> <td> <p>English Units: Test Force (lbf) = [(H-V)/V] x Wt x M If the result of the above calculation is greater than 5000 lb, use 5000 lb as the total compression test weight</p> <p>Metric Units: Test Force (N) = [(H-V)/V] x Wt x M x 9.8 If the result of the above calculation is greater than 22,241 N, use 22,241 N as the total compression test weight</p> </td> </tr> <tr> <td>Weights and a load spreader</td> <td> <p>English Units: Test Force (lb) = [(H-V)/V] x Wt x M If the result of the above calculation is greater than 5,000 lb, use 5,000 lb as the total compression test weight</p> <p>Metric Units: Test Force (kg) = [(H-V)/V] x Wt x M If the result of the above calculation is greater than 2,268 kg, use 2,268 kg as the total compression test weight</p> </td> </tr> </tbody> </table>	IF testing will be performed with...	THEN... Use the appropriate formula below to calculate the required compression test force or the total required compression test weight.	A compression testing machine	<p>English Units: Test Force (lbf) = [(H-V)/V] x Wt x M If the result of the above calculation is greater than 5000 lb, use 5000 lb as the total compression test weight</p> <p>Metric Units: Test Force (N) = [(H-V)/V] x Wt x M x 9.8 If the result of the above calculation is greater than 22,241 N, use 22,241 N as the total compression test weight</p>	Weights and a load spreader	<p>English Units: Test Force (lb) = [(H-V)/V] x Wt x M If the result of the above calculation is greater than 5,000 lb, use 5,000 lb as the total compression test weight</p> <p>Metric Units: Test Force (kg) = [(H-V)/V] x Wt x M If the result of the above calculation is greater than 2,268 kg, use 2,268 kg as the total compression test weight</p>
IF testing will be performed with...	THEN... Use the appropriate formula below to calculate the required compression test force or the total required compression test weight.						
A compression testing machine	<p>English Units: Test Force (lbf) = [(H-V)/V] x Wt x M If the result of the above calculation is greater than 5000 lb, use 5000 lb as the total compression test weight</p> <p>Metric Units: Test Force (N) = [(H-V)/V] x Wt x M x 9.8 If the result of the above calculation is greater than 22,241 N, use 22,241 N as the total compression test weight</p>						
Weights and a load spreader	<p>English Units: Test Force (lb) = [(H-V)/V] x Wt x M If the result of the above calculation is greater than 5,000 lb, use 5,000 lb as the total compression test weight</p> <p>Metric Units: Test Force (kg) = [(H-V)/V] x Wt x M If the result of the above calculation is greater than 2,268 kg, use 2,268 kg as the total compression test weight</p>						

Horizontal Compression (Clamp Testing)

Horizontal compression (clamping simulation) tests are only required in certain situations as follows:

1. Clamp testing, for **Type B, C, D, E, G*, and H**, is required on the Length when the distance between Face 2 and 4 is between 24 in (610 mm) and 75 in (1905 mm).
 - *Type G, during the horizontal compression (clamp testing) TEST BLOCK is conducted with test sample in the intended shipping orientation.
2. Clamp testing, for **Type B, C, D, E, G*, and H**, is required on the Width when the distance between Face 5 and 6 is between 24 in (610 mm) and 75 in (1905 mm).
 - *Type G, during the horizontal compression (clamp testing) TEST BLOCK is conducted with test sample in the intended shipping orientation.
3. No clamping tests are required for **Type A, Type F** and for TV/Monitors less than 50 lbs in **Type G and Type H**.

Clamp Testing Configuration and Forces

The clamp test force must be applied with the clamping platens positioned 3 in (76 mm) up and 3 in (76 mm) over from one corner of the item to be tested, as shown in the figure at right. For TV /Monitors clamping position is 3 in (76 mm) up and flush within the clamps.

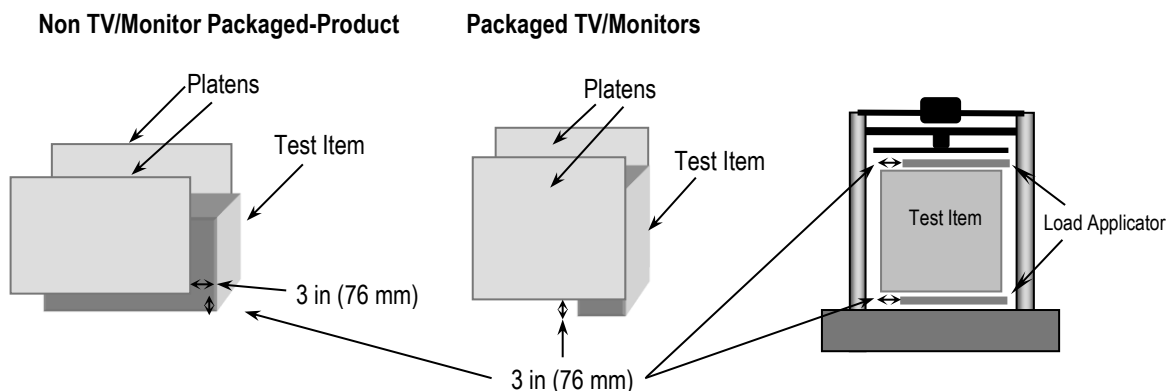

The following formulas are used to calculate required clamp test forces:

- English Units → **Test Force (lbf) = 4 x Wt**
- Metric Units → **Test Force (N) = 39.2 x Wt**

Where **Wt** is the test item weight (lbs) (kg)

Typical handling practice for packaged TV/Monitors is different than Non-TV/Monitor Packaged-Products. Packaged TV/Monitors are clamped one packaged TV/Monitor at a time where as multiple Non-TV/Monitor Packaged-Products are clamped at one time; therefore, the clamp force is distributed across multiple samples. This distribution on clamp force across multiple samples results in a lower minimum clamp test force when only testing one sample in a laboratory. The minimum required clamp test force is:

- **Non TV/Monitor Packaged-Products is 200 lbf (890 N).** If the result of the above calculation is less than this minimum, use 200 lbf (890 N) as the clamp test force.
- **TV/Monitor Packaged-Products is 800 lbf (3559 N).** If the result of the above calculation is less than this minimum, use 800 lbf (3559 N) as the clamp test force.

The maximum required clamp test force is 2000 lbf (8900 N). If the result of the above calculation is greater than this maximum, use 2000 lbf (8900 N) as the clamp test force.

Example:

For a TV/Monitor test item weighing 110 lb (50 kg), the required clamp test force is:

English units → Clamp Test Force (lbf) = 4 x 110 = **440 lbf and since it is less than 800 lbf, default to 800 lbf**

Metric units → Clamp Test Force (N) = 39.2 x 50 = **1960 N and since it is less than 3559 N, default to 3559 N**

BEFORE YOU BEGIN PROJECT 6-AMAZON.COM-SIOC

CAUTION:

A restraining device or devices (fixturing) shall be used with the vibration test system to:

1. Prevent the test specimen from moving off the platform **and**
2. Prevent any Top-Load from moving off the packaged-product being tested **and**
3. Maintain test orientation of any stack of packaged-products, **but**
4. The device or devices shall not restrict the vertical motion of the test specimen during the test.

VIBRATION SPECTRA

1. **Spectra used for Type A, Type B, Type C, and Type G test specimens only**

The following breakpoints are for an Over-the-Road trailer typical for parcel delivery movement and shall be programmed into the vibration controller to produce the acceleration versus frequency profile (spectrum) with an overall G_{rms} level of 0.53 (see below). The theoretical stroke required to run this vibration profile is 1.855 in (47.12 mm) peak to peak:

Frequency (Hz)	PSD Level, g^2/Hz
1.0	0.0007
3.0	0.02
5.0	0.02
7.0	0.001
12.0	0.001
15.0	0.004
24.0	0.004
28.0	0.001
36.0	0.001
42.0	0.003
75.0	0.003
200.0	0.000004

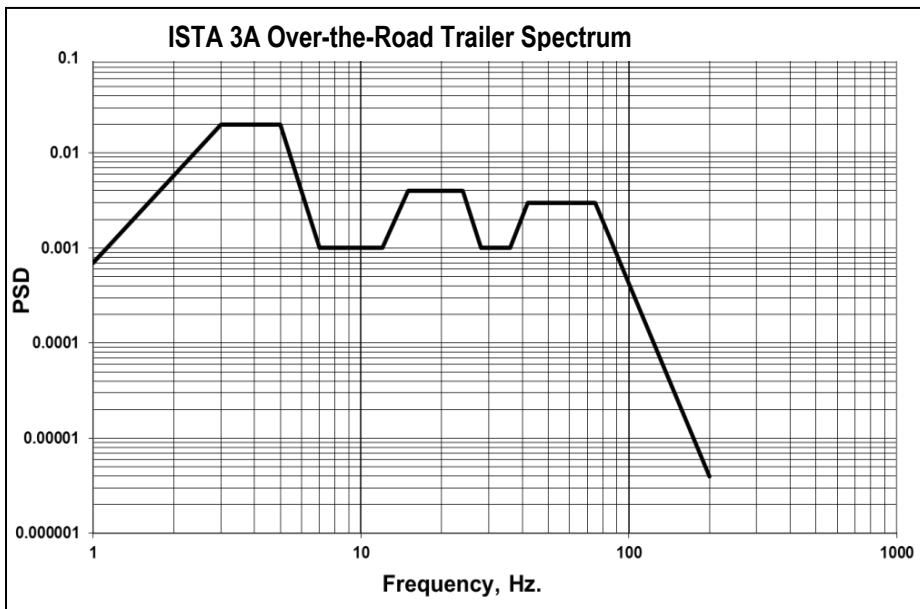

The following breakpoints are for a pick-up and delivery vehicle and shall be programmed into the vibration controller to produce the acceleration versus frequency profile (spectrum) with an overall G_{rms} level of 0.46 (see below). The theoretical stroke required to run this vibration profile is 2.312 in (58.72 mm) peak to peak:

Frequency (Hz)	PSD Level, g^2/Hz
1.0	0.001
3.0	0.035
4.0	0.035
7.0	0.0003
13.0	0.0003
15.0	0.001
24.0	0.001
29.0	0.0001
50.0	0.0001
70.0	0.002
100.0	0.002
200.0	0.00005

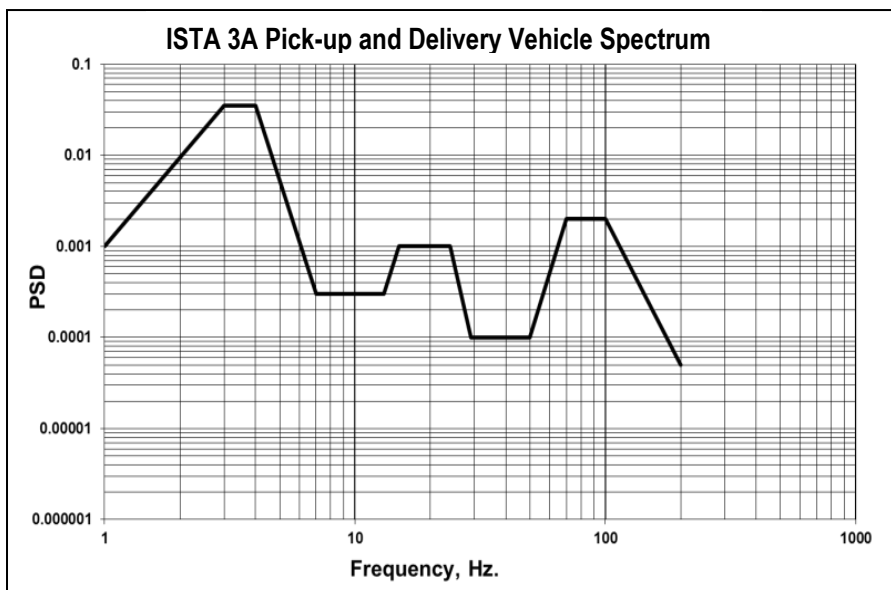

Continued on next page

Continued from previous page

Before You Begin
Vertical
Random
Vibration
Testing
(continued)

2. **Spectra used for Type D, Type E, Type F and Type H test specimens only**

The acceleration vs. frequency spectrum to be used for the random vibration tests is shown below. The overall Grms is 0.54 and the theoretical stroke required is 1.777 in (45.13 mm) peak to peak.

Frequency (Hz)	PSD (g ² /Hz)
1.0	0.00072
3.0	0.018
4.0	0.018
6.0	0.00072
12.0	0.00072
16.0	0.0036
25.0	0.0036
30.0	0.00072
40.0	0.0036
80.0	0.0036
100.0	0.00036
200.0	0.000018

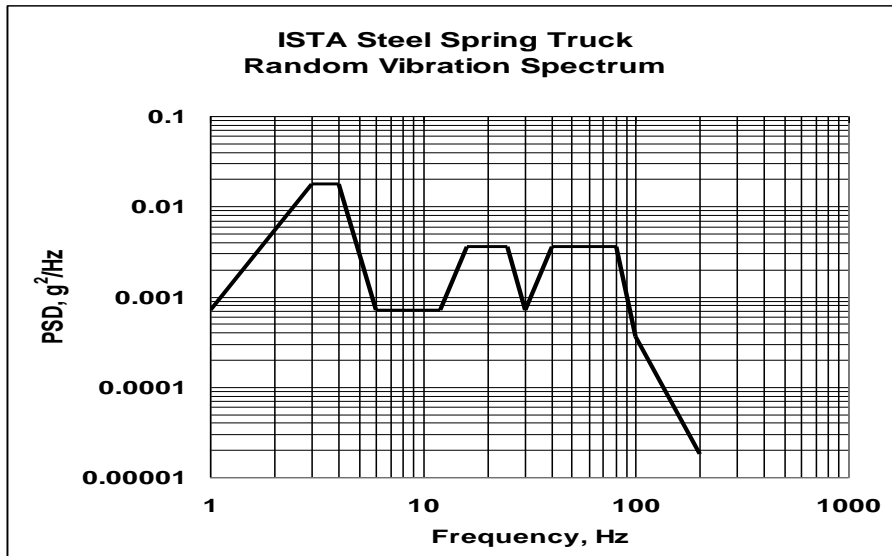

VIBRATION TOP LOAD Overview

Vibration tests of packaged-product require that a weight or weights (top load) be placed on the test item as shown in the *Equipment Required Additional, Vibration Top Load Apparatus* section. The following explains how to determine and configure this top load.

Top Load Apparatus Axis Definitions

The Top Load Apparatus shall be defined as:

- **TL-H** for the Apparatus used when the packaged-product is positioned for testing with **face 1** or **face 3** down.
- **TL-W** for the Apparatus used when the packaged-product is positioned for testing with **face 2** or **face 4** down.
- **TL-L** for the Apparatus used when the packaged-product is positioned for testing with **face 5** or **face 6** down.

Determination of Vibration Top Load

- First, calculate the theoretical top loads from the **Total Theoretical Top Loads** table below.
- Next, determine the number of apparatus required from the **Division of Top Load Apparatus** table at the bottom of this page.
- Then, go to the **Determination of Top Load Apparatus Weight** table on the next page to determine the actual weights of the top loads to be used.

NOTE: Different Top Loads may be required depending upon the packaged-product dimensions and how it is oriented for the vibration tests.

Total Theoretical Top Loads			
Total Theoretical Top Load Formulas		English Units (in), Load Results in lb	Metric Units (m), Load Results in kg
Theoretical Top Load with face 1 or face 3 down		$(108 - H) \times L \times W \times 0.0035$	$(2.7 - H) \times L \times W \times 96$
Theoretical Top Load with face 2 or face 4 down		$(108 - W) \times L \times H \times 0.0035$	$(2.7 - W) \times L \times H \times 96$
Theoretical Top Load with face 5 or face 6 down		$(108 - L) \times W \times H \times 0.0035$	$(2.7 - L) \times W \times H \times 96$
Where	Represents		
108 and 2.7	Height of typical trailer or ocean container	Inches (in)	Meters (m)
L	Length of shipping unit based upon predetermined testing orientation	Inches (in)	Meters (m)
W	Width of shipping unit based upon predetermined testing orientation	Inches (in)	Meters (m)
H	Height of shipping unit based upon predetermined testing orientation	Inches (in)	Meters (m)
0.0035 and 96	Dynamic loading factor: 50% of the average static density of freight	0.0035 lb/in ³	96 kg/m ³

Δ – Most recent technical change(s)

○ – Most recent technical addition(s)

Continued from previous page

Before You
Begin
Vertical
Random
Vibration
Testing
(continued)

Division of top load apparatus is <u>ONLY</u> required for <u>Type D, Type E, Type F and Type H</u> packaged-products. The top load apparatus for <u>Type A, B, C and G</u> packaged-products shall not be divided. To determine if and how the vibration Top Load should be divided, orient the packaged-product for testing and follow the instructions below:	
IF the packaged-product top surface when in the testing orientation exceeds 18 inches (460 mm) in...	THEN there shall be...
neither dimension	an <i>undivided</i> Top Load apparatus.
only one dimension	A <i>two portion</i> Top Load apparatus, with the two separate portions of equal size and weight and divided along the packaged-product's longer dimension.
both dimensions	a <i>four portion</i> Top Load apparatus with the four separate portions of equal size and weight.

Determination of Top Load Apparatus Weight Determine the Top Load Apparatus weight (or weights, for multiple apparatus) to be used for vibration tests as follows:	
IF the calculation from the Total Theoretical Top Loads chart (previous page) for an axis is ...	THEN ...
Less than 25 lb (11kg)	Do not use a Top Load Apparatus for that axis during vibration testing.
300 lb (136 kg) or greater for Type A or Type B or Type C or Type G packaged-products	Use 300 lb (136 kg) as the Total Theoretical Top Load in the following calculations.
600 lb (272 kg) or greater for Type D or Type E or Type F or Type H packaged-products	Use 600 lb (272 kg) as the Total Theoretical Top Load in the following calculations.
25 lb (11 kg) or greater and an undivided Top Load Apparatus is required	Round the Total Theoretical Top Load value up to the nearest 5 lb (2 kg) and use the rounded weight value as the total Top Load Apparatus weight for that axis.
25 lb (11 kg) or greater and two equal Top Load Apparatus are required	Divide the Total Theoretical Top Load value by 2, then round the result up to the nearest 2 lb (1 kg) and use the rounded weight value as the weight for each of the two Top Load Apparatus for that axis.
25 lb (11 kg) or greater and four equal Top Load Apparatus are required	Divide the Total Theoretical Top Load value by 4, then round the result up to the nearest 1 lb (0.5 kg) and use the rounded weight value as the weight for each of the four Top Load Apparatus for that axis.
No vibration top load is required for vibration testing in a particular orientation if the packaged-product's vertical dimension in that orientation is 72 in (1.8 m) or more.	
<i>Examples:</i>	
<ul style="list-style-type: none"> • If the Total Theoretical Top Load value is 166 lb (75.3 kg) and only one Top Load Apparatus is required, round up to the nearest 5 lb (2 kg) and use 170 lb (or 76 kg) as the Top Load Apparatus weight. • If the Total Theoretical Top Load value is 166 lb (75.3 kg) and two Top Load Apparatus are required, divide by 2 to get 83 lb (37.6 kg), round up to the nearest 2 lb (1 kg) and use 84 lb (or 38 kg) as the weight of each of the two Top Load Apparatus. • If the Total Theoretical Top Load value is 166 lb (75.3 kg) and four Top Load Apparatus are required, divide by 4 to get 41.5 lb (18.8 kg), round up to the nearest 1 lb (0.5 kg) and use 42 lb (or 19 kg) as the weight of each of the four Top Load Apparatus. 	

TEST SEQUENCE FOR PROJECT 6-AMAZON.COM-SIOC

The following TEST BLOCKS contain tables indicating the required steps for each test in the procedure. Start with TEST BLOCK 1 below for all packaged-product types covered by this procedure.

TEST BLOCK 1
Atmospheric
Conditioning,
Temperature and
Humidity

ATMOSPHERIC CONDITIONING, TEMPERATURE AND HUMIDITY							
Step	Action						
1	Atmospheric preconditioning: The packaged-product must be stored at laboratory ambient temperature and humidity for not less than twelve (12) hours prior to testing.						
2	Is atmospheric conditioning going to be performed (optional for Non-Perishable packaged-products)? <ul style="list-style-type: none"> • If Yes, go to Step 3 of this TEST BLOCK. • If No, go to Step 8 of this TEST BLOCK. 						
3	Select a temperature and humidity condition from <i>Before You Begin Atmospheric Conditioning</i> .						
4	Check the conditioning apparatus to insure that the temperature and humidity are at the required levels.						
5	Place the packaged-product in the conditioning apparatus for the specified time.						
6	At the completion of the selected conditioning, remove the packaged-product from the conditioning apparatus.						
7	Conditioning is now complete. When testing starts (according to the appropriate TEST BLOCK as indicated below), record the ambient temperature and humidity. At the end of all testing record the ambient temperature and humidity.						
8	Perform the remaining test sequences as quickly as possible. The best approach is to perform all tests directly in the conditioned atmosphere as appropriate. If this is not possible, then tests should be performed quickly after removal of test items from the conditioned atmosphere, and items should be returned periodically to conditioning as necessary to maintain the required control. Temperature and humidity should be recorded on the test report, along with amount of time the item was returned to conditioning.						
9	This TEST BLOCK is now complete. Determine the next TEST BLOCK to be used as follows:						
	<table border="1"> <thead> <tr> <th>IF the packaged-product type is...</th> <th>THEN go to...</th> </tr> </thead> <tbody> <tr> <td> <ul style="list-style-type: none"> • Type A, Parcel Delivery of Individual Packaged-Products Less Than 50 lb (23 kg) or • Type B, Parcel Delivery of Individual Packaged-Products 50 lb (23 kg) to Less Than 100 lb (45 kg) or • Type G, Parcel Delivery of TV/Monitor Weight Less Than 150 lb (68 kg) and Girth Less Than 165 in (4.19 m) </td> <td>TEST BLOCK 2 (Shock: Free-Fall Drop).</td> </tr> <tr> <td> <ul style="list-style-type: none"> • Type C, Parcel Delivery of Individual Packaged-Products 100 lb (45 kg) or Greater or • Type D, LTL Delivery of Individual Packaged-Products Less Than 100 lb (45 kg) or • Type E, LTL Delivery of Individual Packaged-Products 100 lb (45 kg) or Greater or • Type F, LTL Delivery of Individual Palletized Packaged-Products or • Type H, LTL Delivery of TV/Monitor with Weight 150 lbs (68 kg) or Greater or Girth 165 in (4.19 m) or Greater </td> <td>TEST BLOCK 3 (Shock: Tip/Tip Over).</td> </tr> </tbody> </table>	IF the packaged-product type is...	THEN go to...	<ul style="list-style-type: none"> • Type A, Parcel Delivery of Individual Packaged-Products Less Than 50 lb (23 kg) or • Type B, Parcel Delivery of Individual Packaged-Products 50 lb (23 kg) to Less Than 100 lb (45 kg) or • Type G, Parcel Delivery of TV/Monitor Weight Less Than 150 lb (68 kg) and Girth Less Than 165 in (4.19 m) 	TEST BLOCK 2 (Shock: Free-Fall Drop).	<ul style="list-style-type: none"> • Type C, Parcel Delivery of Individual Packaged-Products 100 lb (45 kg) or Greater or • Type D, LTL Delivery of Individual Packaged-Products Less Than 100 lb (45 kg) or • Type E, LTL Delivery of Individual Packaged-Products 100 lb (45 kg) or Greater or • Type F, LTL Delivery of Individual Palletized Packaged-Products or • Type H, LTL Delivery of TV/Monitor with Weight 150 lbs (68 kg) or Greater or Girth 165 in (4.19 m) or Greater 	TEST BLOCK 3 (Shock: Tip/Tip Over).
IF the packaged-product type is...	THEN go to...						
<ul style="list-style-type: none"> • Type A, Parcel Delivery of Individual Packaged-Products Less Than 50 lb (23 kg) or • Type B, Parcel Delivery of Individual Packaged-Products 50 lb (23 kg) to Less Than 100 lb (45 kg) or • Type G, Parcel Delivery of TV/Monitor Weight Less Than 150 lb (68 kg) and Girth Less Than 165 in (4.19 m) 	TEST BLOCK 2 (Shock: Free-Fall Drop).						
<ul style="list-style-type: none"> • Type C, Parcel Delivery of Individual Packaged-Products 100 lb (45 kg) or Greater or • Type D, LTL Delivery of Individual Packaged-Products Less Than 100 lb (45 kg) or • Type E, LTL Delivery of Individual Packaged-Products 100 lb (45 kg) or Greater or • Type F, LTL Delivery of Individual Palletized Packaged-Products or • Type H, LTL Delivery of TV/Monitor with Weight 150 lbs (68 kg) or Greater or Girth 165 in (4.19 m) or Greater 	TEST BLOCK 3 (Shock: Tip/Tip Over).						

TEST SEQUENCE FOR PROJECT 6-AMAZON.COM-SIOC

SHOCK: FREE-FALL DROP, PARCEL CARRIER (First Sequence)

Complete this TEST BLOCK for the following types of packaged-products only, using the drop heights indicated:

- **Type A**, Parcel Delivery of Packaged-Products Less Than 50 lb (23 kg)
- **Type B**, Parcel Delivery of Packaged-Products 50 lb (23 kg) to Less Than 100 lb (45 kg)
- **Type G**, Parcel Delivery of TV/Monitor Weight Less Than 150 lb (68 kg) and Girth Less Than 165 in (4.19 m)

***Note: For package Type G, do not catch the package after each free-fall impact.**

Step	Action			
1	Drop Number	< 70 lb (32 kg)	70-150 lb (32-68 kg)	Orientation
	1	18 in (460 mm)	12 in (300 mm)	Edge 3-4
	2	18 in (460 mm)	12 in (300 mm)	Edge 3-6
	3	18 in (460 mm)	12 in (300 mm)	Edge 4-6
	4	18 in (460 mm)	12 in (300 mm)	Corner 3-4-6
	5	18 in (460 mm)	12 in (300 mm)	Corner 2-3-5
	6	18 in (460 mm)	12 in (300 mm)	Edge 2-3
	7	18 in (460 mm)	12 in (300 mm)	Edge 1-2
	8	36 in (910 mm)	24 in (610 mm)	Face 3
	9	18 in (460 mm)	12 in (300 mm)	Face 3
2	This TEST BLOCK is now complete. Determine the next TEST BLOCK to be used as follows:			
	IF the packaged-product is...			THEN...
	Type A , Parcel Delivery of Individual Packaged-Products Less Than 50 lb (23 kg) Type G , Parcel Delivery of TV/Monitor Less than 50 Lbs (23kg)			Go to TEST BLOCK 12 (Vibration: Random With and Without Top Load).
	Type B , Parcel Delivery of Individual Packaged-Products 50 lb (23 kg) to Less Than 100 lb (45 kg)			Go to TEST BLOCK 3 (Shock: Tip/Tipover).
Type G , Parcel Delivery of TV/Monitor 50 lb (23 kg) to Less Than 150 lb (68 kg)			Go to TEST BLOCK 9 [Compression: Horizontal (Clamping)].	

TEST SEQUENCE FOR PROJECT 6-AMAZON.COM-SIOC

SHOCK: TIP/TIPOVER

Complete this TEST BLOCK for the following types of packaged-products: **Type B, Type C, Type D, Type E, Type F, or Type H**

Note: Required **ONLY** for packages ≥48 in. (1.2 m) tall **and** any one base dimension < ½ the height;
or
for packages ≥ 30 in. (760 mm) tall **and** with a center of gravity vertical location > ½ the package height.

Step	Action	
1	Place the packaged-product on the floor in its intended shipping orientation.	
2	Using any method, but without sliding or moving the packaged-product horizontally, slowly tilt it from its vertical position to a 22° tip angle in one of the potentially unstable directions.	
3	IF the packaged-product...	THEN ...
	Begins to tip over and fall at or before the specified angle is reached	Allow it to fall and impact the floor.
	Does not tip over and fall at a 22° angle	Slowly and gently return the packaged-product to its upright orientation.
4	Repeat steps 2 and 3 of this TEST BLOCK for all four (4) potentially unstable directions of the packaged-product.	
5	This TEST BLOCK is now complete. Determine the next TEST BLOCK to be used as follows:	
	IF the packaged-product is...	THEN...
	Type B , Parcel Delivery of Individual Packaged-Products 50 lb (23 kg) to Less Than 100 lb (45 kg)	Go to TEST BLOCK 9 [Compression: Horizontal (Clamping)].
	Type D , LTL Delivery of Individual Packaged-Products Less Than 100 lb (45 kg) Type H , LTL Delivery of TV/Monitor Less Than 100 lb (45kg)	Go to TEST BLOCK 4 (Shock: Free-Fall Drop).
	Type C , Parcel Delivery of Individual Packaged-Products 100 lb (45 kg) or Greater or Type E , LTL Delivery of Individual Packaged-Products 100 lb (45 kg) or Greater or Type F , LTL Delivery of Individual Palletized Packaged-Products Type H , LTL Delivery of TV/Monitor Packaged-Products 150 lb (68 kg) or Greater	Go to TEST BLOCK 5 (Shock: Rotation Flat Drop).

TEST BLOCK 4
Shock:
Free-Fall Drop,
LTL Carrier
(First Sequence)

TEST SEQUENCE FOR PROJECT 6-AMAZON.COM-SIOC

SHOCK: FREE-FALL DROP, LTL CARRIER (FIRST SEQUENCE)

Complete this TEST BLOCK for **Type D and Type H**; Individual & TV/Monitor Packaged-Products for LTL Delivery Less Than 100 lb (45 kg).

***Note: For package Type H, do not catch the package after each free-fall impact.**

Step	Action		
1	Perform 6 drop tests of the individual case or unit, in accordance with the table below and in the order listed.		
	Drop Number	Drop Heights	Orientation of Drop
	1	12 in (300 mm)	Face 1
	2	12 in (300 mm)	Face 2
	3	12 in (300 mm)	Face 6
	4	12 in (300 mm)	Corner 2-3-5
	5	12 in (300 mm)	Edge 3-4
6	18 in (460 mm)	Face 3	
2	This TEST BLOCK is now complete. Go to TEST BLOCK 9 [Compression: Horizontal (Clamping)].		

TEST SEQUENCE FOR PROJECT 6-AMAZON.COM-SIOC

SHOCK: ROTATIONAL FLAT DROP

TEST BLOCK 5
Shock:
Rotational
FLAT Drop

Complete this TEST BLOCK for the following types of packaged-products only, using the drop height indicated:

- **Type C**, Parcel Delivery of Individual Packaged-Products 100 lb (45 kg) or Greater or
- **Type E**, LTL Delivery of Individual Packaged-Products 100 lb (45 kg) or Greater or
- **Type F**, LTL Delivery of Individual Palletized Packaged-Products or
- **Type H**, LTL Delivery of TV/Monitor 150 lb (68 kg) or Greater

The test is performed starting with the test item resting on a flat, rigid surface such as steel or concrete. Lift one edge to the prescribed drop height. Quickly release the edge so that the test item falls freely.

If the packaged-product in a particular orientation topples over before a side or edge can be lifted to the required drop height, then the rotational drop is not possible.

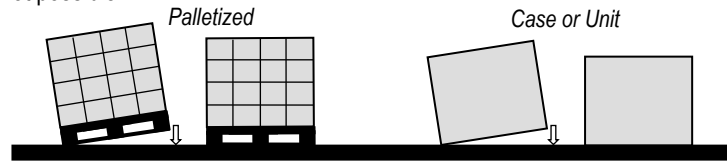

Step	Action	
1	The drop height required for this test as follows: 9 in (230 mm)	
2	Determine the next Step of this TEST BLOCK to be used as follows:	
	IF the packaged-product type is...	THEN go to...
	Type C , Parcel Delivery of Individual Packaged-Products 100 lb (45 kg) or Greater or Type E , LTL Delivery of Individual Packaged-Products 100 lb (45 kg) or Greater or Type H , LTL Delivery of TV/Monitor 150 lbs (68 kg) or Greater	Step 3 of this TEST BLOCK.
	Type F , LTL Delivery of Individual Palletized Packaged-Products	Step 4 of this TEST BLOCK.
3	Sequence #	Action
	1	Place the packaged-product on a flat, rigid surface such as steel or concrete with face 3 down.
	2	Lift edge 3-4 to the drop height prescribed in Step 1 of this TEST BLOCK. Quickly release the edge so that it falls freely.
	3	Lift edge 3-5 to the drop height prescribed in Step 1 of this TEST BLOCK. Quickly release the edge so that it falls freely.
	4	Place the packaged-product on a flat, rigid surface such as steel or concrete with face 2 down.
	5	Lift edge 2-5 to the drop height prescribed in Step 1 of this TEST BLOCK. Quickly release the edge so that it falls freely.
	6	Lift edge 2-1 to the drop height prescribed in Step 1 of this TEST BLOCK. Quickly release the edge so that it falls freely.
	7	Place the packaged-product on a flat, rigid surface such as steel or concrete with face 6 down.
	8	Lift edge 6-4 to the drop height prescribed in Step 1 of this TEST BLOCK. Quickly release the edge so that it falls freely.
	9	Lift edge 6-1 to the drop height prescribed in Step 1 of this TEST BLOCK. Quickly release the edge so that it falls freely.
10	Go to Step 5 of this TEST BLOCK.	

Continued on next page.

TEST SEQUENCE FOR PROJECT 6-AMAZON.COM-SIOC

Continued from previous page.

SHOCK: ROTATIONAL FLAT DROP

4	Sequence #	Action
	1	Place the packaged-product on a flat, rigid surface such as steel or concrete with face 3 down.
	2	Lift edge 3-4 to the drop height prescribed in Step 1 of this TEST BLOCK. Quickly release the edge so that it falls freely.
	3	Lift edge 3-5 to the drop height prescribed in Step 1 of this TEST BLOCK. Quickly release the edge so that it falls freely.
	4	Go to Step 5 of this TEST BLOCK.
5	This TEST BLOCK is now complete. Go to TEST BLOCK 6 (Shock: Rotational EDGE Drop).	

SHOCK: ROTATIONAL EDGE DROP

Complete this TEST BLOCK for the following types of packaged-products only, using the drop height indicated:

- **Type C**, Parcel Delivery of Individual Packaged-Products 100 lb (45 kg) or Greater **or**
- **Type E**, LTL Delivery of Individual Packaged-Products 100 lb (45 kg) or Greater **or**
- **Type F**, LTL Delivery of Individual Palletized Packaged-Products **or**
- **Type H**, LTL Delivery of TV/Monitor 100 lb (45 kg) or Greater

The test is performed on a flat, rigid surface such as steel or concrete. One edge is supported with a timber or equivalent support, the opposite edge is lifted and then released quickly so that it falls freely and strikes the surface.

If the packaged-product in a particular orientation topples over before a side or edge can be lifted to the required support or drop height, then the rotational drop is not possible.

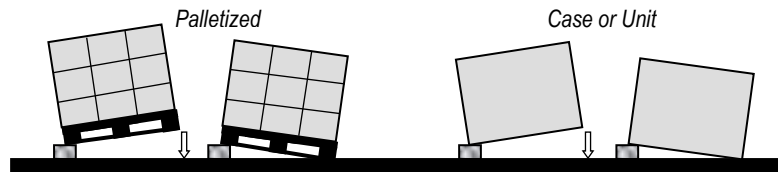

Step	Action	
1	The drop height required for this test as follows: 9 in (230 mm)	
2	Determine the next Step of this TEST BLOCK to be used as follows:	
	IF the packaged-product type is...	THEN go to...
	Type C , Parcel Delivery of Individual Packaged-Products 100 lb (45 kg) or Greater or Type E , LTL Delivery of Individual Packaged-Products 100 lb (45 kg) or Greater or Type H , LTL Delivery of TV/Monitor 100 lb (45 kg) or Greater Type F , LTL Delivery of Individual Palletized Packaged-Products	Step 3 of this TEST BLOCK. Step 4 of this TEST BLOCK.
3	Sequence #	Action
	1	Place the packaged-product on a flat, rigid surface such as steel or concrete with face 1 down.
	2	Place edge 1-5 on a timber or equivalent support 3.5 to 4.0 in (90 to 100 mm) in height. Lift edge 1-6 to the drop height prescribed in Step 1 of this TEST BLOCK. Quickly release the edge so that it falls freely.
	3	Place edge 1-4 on a timber or equivalent support 3.5 to 4.0 in (90 to 100 mm) in height. Lift edge 1-2 to the drop height prescribed in Step 1 of this TEST BLOCK. Quickly release the edge so that it falls freely.
	4	Place the packaged-product on a flat, rigid surface such as steel or concrete with face 4 down.
	5	Place edge 4-5 on a timber or equivalent support 3.5 to 4.0 in (90 to 100 mm) in height. Lift edge 4-6 to the drop height prescribed in Step 1 of this TEST BLOCK. Quickly release the edge so that it falls freely.
	6	Place edge 4-1 on a timber or equivalent support 3.5 to 4.0 in (90 to 100 mm) in height. Lift edge 4-3 to the drop height prescribed in Step 1 of this TEST BLOCK. Quickly release the edge so that it falls freely.
7	Place the packaged-product on a flat, rigid surface such as steel or concrete with face 5 down.	

Continued on next page

TEST BLOCK 5
Shock:
Rotational
FLAT Drop
(continued)

TEST BLOCK 6
Shock:
Rotational
EDGE Drop

TEST SEQUENCE FOR PROJECT 6-AMAZON.COM-SIOC

Continued from previous page

TEST BLOCK 6
Shock:
Rotational
EDGE Drop
(continued)

SHOCK: ROTATIONAL EDGE DROP		
3	8	Place edge 5-4 on a timber or equivalent support 3.5 to 4.0 in (90 to 100 mm) in height. Lift edge 5-2 to the drop height prescribed in Step 1 of this TEST BLOCK. Quickly release the edge so that it falls freely.
	9	Place edge 5-1 on a timber or equivalent support 3.5 to 4.0 in (90 to 100 mm) in height. Lift edge 5-3 to the drop height prescribed in Step 1 of this TEST BLOCK. Quickly release the edge so that it falls freely.
	10	Go to Step 5 of this TEST BLOCK.
4	Sequence #	Action
	1	Place the packaged-product on a flat, rigid surface such as steel or concrete with face 3 down.
	2	Place edge 3-5 on a timber or equivalent support 3.5 to 4.0 in (90 to 100 mm) in height. Lift edge 3-6 to the drop height prescribed in Step 1 of this TEST BLOCK. Quickly release the edge so that it falls freely.
	3	Place edge 3-4 on a timber or equivalent support 3.5 to 4.0 in (90 to 100 mm) in height. Lift edge 3-2 to the drop height prescribed in Step 1 of this TEST BLOCK. Quickly release the edge so that it falls freely.
	4	Go to Step 5 of this TEST BLOCK.
5	This TEST BLOCK is now complete. Determine the next TEST BLOCK or section to be used as follows:	
	IF the packaged-product is...	THEN...
	<ul style="list-style-type: none"> • Type C, Individual Packaged-Products for Parcel Delivery 100 lb (45 kg) or Greater or • Type E, LTL Delivery of Individual Packaged-Products 100 lb (45 kg) or Greater or • Type H, LTL Delivery of TV/Monitor 100 lb (45 kg) or Greater 	Go to TEST BLOCK 8 (Shock: Inclined or Horizontal Impact).
	Type F , Palletized Individual Packaged-Products for LTL Delivery	Go to TEST BLOCK 7 (Shock: Rotational Corner Drop).

TEST BLOCK 7
Shock:
Rotational
CORNER Drop

SHOCK: ROTATIONAL CORNER DROP		
<p>Complete this TEST BLOCK for Type F, LTL Delivery of Individual Palletized Packaged-Products.</p> <p>The test is performed on a flat, rigid surface such as steel or concrete. One corner is supported with a timber or equivalent support, the opposite corner is lifted and then released quickly so that it falls freely and strikes the surface.</p> <p>If the packaged-product in a particular orientation topples over before a corner can be lifted to the required support or drop height, then the rotational drop is not possible.</p>		
Step	Action	
1	The drop height required for this test as follows: 9 in (230 mm)	
2	Sequence #	Action
	1	Place the packaged-product on a flat, rigid surface such as steel or concrete with face 3 down.
	2	Place corner 3-2-6 on a timber or equivalent support 3.5 to 4.0 in (90 to 100 mm) in height. Lift corner 3-4-5 to the drop height prescribed in Step 1 of this TEST BLOCK. Quickly release the edge so that it falls freely.
	3	Place corner 3-4-6 on a timber or equivalent support 3.5 to 4.0 in (90 to 100 mm) in height. Lift corner 3-2-5 to the drop height prescribed in Step 1 of this TEST BLOCK. Quickly release the edge so that it falls freely.
	4	Go to Step 4 of this TEST BLOCK.
3	This TEST BLOCK is now complete. Go to TEST BLOCK 8 (Shock: Inclined or Horizontal Impact).	

TEST SEQUENCE FOR PROJECT 6-AMAZON.COM-SIOC

TEST BLOCK 8
Shock:
Inclined or
Horizontal
Impact
(First Sequence)

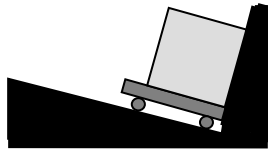
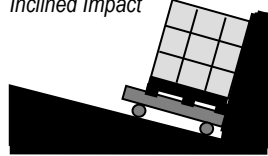
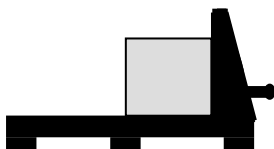
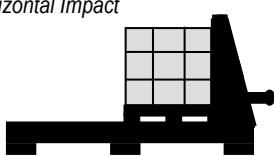
SHOCK: INCLINED OR HORIZONTAL IMPACT		
Complete this TEST BLOCK for the following all types of packaged-products:		
Step	Action	
1	IF the packaged-product type is... <ul style="list-style-type: none"> • Type C, Parcel Delivery of Individual Packaged-Products 100 lb (45 kg) or Greater or • Type E, LTL Delivery of Individual Packaged-Products 100 lb (45 kg) or Greater or • Type H, LTL Delivery of Packaged TV/Monitors 100 lb (45 kg) or Greater 	THEN go to... Step 2 of this TEST BLOCK.
	<ul style="list-style-type: none"> • Type F, LTL Delivery of Individual Palletized Packaged-Products 	Step 3 of this TEST BLOCK.
2	Center the packaged-product in the proper orientation (see below) on the carriage, with its front surface in contact with the backstop or sail and parallel to the leading edge of the carriage. Impact (3) of the packaged-product's faces as described in Step 4 of this TEST BLOCK. Impact the faces in the following order: Face 5, Face 1, Face 6. Then go to Step 5 of this TEST BLOCK.	
3	Center the packaged-product in the proper orientation (see below) on the carriage, with its front surface in contact with the backstop or sail and parallel to the leading edge of the carriage. If the packaged-product is a palletized load and the load footprint is smaller than the pallet top surface (an underhung load), place the front edge of the pallet in contact the backstop or sail and parallel to the leading edge of the carriage. In this case there will be a gap between the front surface of the load and the backstop or sail. Impact test each of the packaged-product's vertical faces as described in Step 4 of this TEST BLOCK. Impact the faces in the following order: Face 2, Face 4, Face 5, Face 6. Then go to Step 5 of this TEST BLOCK.	
4	Draw the carriage back and impact test the packaged-product on each of the faces as directed. The minimum required <i>impact velocity</i> for an inclined-impact test is 48 in/sec (4 ft/sec) (1.2 m/sec). The minimum required <i>velocity change</i> for a horizontal impact test is 48 in/sec (4 ft/sec) (1.2 m/sec) and the shock must be a nominal 10 millisecond half sine pulse. If any velocity in the Test Sequence is below the required minimum value, that sequence event must be repeated until the test velocity meets the minimum.	
<div style="display: flex; justify-content: space-around; align-items: center;"> <div style="text-align: center;">  <p>Inclined Impact</p>  </div> <div style="text-align: center;">  <p>Horizontal Impact</p>  </div> </div>		
5	IF the packaged-product type is... <ul style="list-style-type: none"> • Type C, Parcel Delivery of Individual Packaged-Products 100 lb (45 kg) or Greater or • Type E, LTL Delivery of Individual Packaged-Products 100 lb (45 kg) or Greater or • Type H, LTL Delivery of Packaged TV/Monitors 100 lb (45 kg) or Greater 	THEN go to... Go to TEST BLOCK 9 [Compression: Horizontal (Clamping)].
	Type F , LTL Delivery of Individual Palletized Packaged-Products	Go to TEST BLOCK 10 [Compression: Vertical (Top-to-Bottom)].

TEST SEQUENCE FOR PROJECT 6-AMAZON.COM-SIOC

COMPRESSION, HORIZONTAL: CLAMPING SIMULATION

Complete this TEST BLOCK for the following types of packaged-products:

- **Type B**, Parcel Delivery of Individual Packaged-Products 50 lb (23 kg) to Less Than 100 lb (45 kg) or
- **Type C**, Parcel Delivery of Individual Packaged-Products 100 lb (45 kg) or Greater or
- **Type D**, LTL Delivery of Individual Packaged-Products Less Than 100 lb (45 kg) or
- **Type E**, LTL Delivery of Individual Packaged-Products 100 lb (45 kg) or Greater or
- **Type G**, Parcel Delivery of TV/Monitor 150 lb (68 kg) or Less and Girth Less Than 165 in (4.19 m) or
- **Type H**, LTL Delivery of Packaged TV/Monitors 150 lb (45 kg) or Greater or Girth Greater Than 165 in (4.19 m)

Note: See the *Before You Begin Handling: Clamping Simulation Testing* section. No clamping tests are required for **Type G and Type H TV/Monitors less than 50 lbs.**

Step	Action	
1	IF the packaged-product type is...	THEN go to...
	<ul style="list-style-type: none"> • Type B, Parcel Delivery of Individual Packaged-Products 50 lb (23 kg) to Less Than 100 lb (45 kg) or • Type C, Parcel Delivery of Individual Packaged-Products 100 lb (45 kg) or Greater or • Type D, LTL Delivery of Individual Packaged-Products Less Than 100 lb (45 kg) or • Type E, LTL Delivery of Individual Packaged-Products 100 lb (45 kg) or Greater 	Step 2 of this TEST BLOCK.
2	<ul style="list-style-type: none"> • Type G, Parcel Delivery of Packaged TV/Monitors 150 lb (45 kg) or Less and Girth Less Than 165 in (4.19 m) • Type H, LTL Delivery of Packaged TV/Monitors Greater Than 150 lb (45 kg) or Girth Greater Than 165 in (4.19 m) 	Step 4 of this TEST BLOCK.
	Determine the required compression (clamping) test force by first calculating values from the formulas in the "Clamp Testing Configuration and Forces" section of <i>Before You Begin Horizontal Compression Testing (Clamping Simulation)</i> .	
3	IF the calculated value is 200 lbf (890 N) or below	THEN use 200 lbf (890 N) as the clamping test force.
	IF the calculated value is 2000 lbf (8900 N) or above	THEN use 2000 lbf (8900 N) as the clamping test force.
	IF the calculated value is between 200 lbf (890 N) and 2000 lbf (8900 N)	THEN use the calculated value for the clamping test force.
4	IF testing will be performed with...	THEN go to...
	A clamp testing machine A compression testing machine	Step 6 of this TEST BLOCK. Step 23 of this TEST BLOCK.
5	Determine the required compression (clamping) test force by first calculating values from the formulas in the "Clamp Testing Configuration and Forces" section of <i>Before You Begin Horizontal Compression Testing (Clamping Simulation)</i> .	
	IF the calculated value is 800 lbf (3559 N) or below	THEN use 800 lbf (3559 N) as the clamping test force.
	IF the calculated value is 2000 lbf (8900 N) or above	THEN use 2000 lbf (8900 N) as the clamping test force.
6	IF the calculated value is between 800 lbf (3559 N) and 2000 lbf (8900 N)	THEN use the calculated value for the clamping test force.
	IF testing will be performed with...	THEN go to...
7	A clamp testing machine A compression testing machine	Step 14 of this TEST BLOCK. Step 32 of this TEST BLOCK.

Continued on next page.

TEST SEQUENCE FOR PROJECT 6-AMAZON.COM-SIOC

Continued from previous page

TEST BLOCK 9
Compression,
Horizontal:
Clamping
Simulation
(continued)

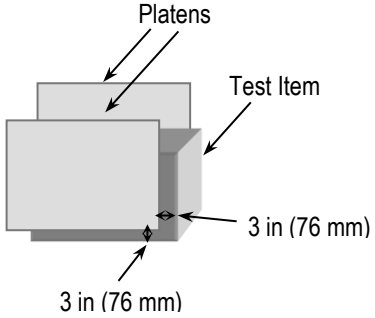
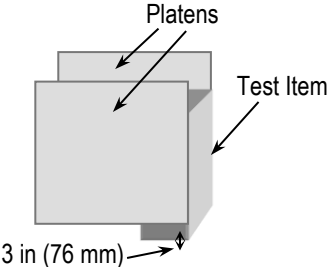
COMPRESSION, HORIZONTAL: CLAMPING SIMULATION	
Step	Action
6	Place the test specimen on a flat, level surface with face 3 down. IF the distance between faces 2 and 4 is less than 24 in (610 mm) OR greater than 75 in (1905 mm), go to Step 11. If not, proceed to the next step.
7	<p>Position the clamp tester platens near faces 2 and 4, each platen <u>up</u> 3 in (76 mm) and <u>back</u> 3 in (76 mm) from the corners of the test item as shown in the figure at right. Go to next step.</p> 
8	Start moving the clamp tester platens toward each other at a consistent rate to apply a horizontal compression force to faces 2 and 4 of the test item. Increase the compression force until it reaches the value determined in Step #2 above.
9	Raise the test specimen approximately 12" (305 mm) off the floor and maintain the compression force for 30 seconds, then lower the test specimen and release.
10	Repeat Steps #7-9 until a total of 5 force applications to faces 2 and 4 of the test specimen have been accomplished.
11	IF the distance between faces 5 and 6 is less than 24 in (610 mm) OR greater than 75 in (1905 mm), go to then go to the end of the TEST BLOCK.
12	Perform Steps #7-9 but applying the clamping force determined in Step #2 of this TEST BLOCK to packaged-product faces 5 and 6.
13	Repeat Step #12 of this TEST BLOCK until a total of 5 force applications to faces 5 and 6 of the test specimen have been accomplished then go to the end of the TEST BLOCK.
14	Place the Type G or H (TV/Monitor) test specimen on a flat, level surface and in the clamps in its <u>intended shipping orientation</u> . IF the distance between the smallest faces (face 5 and 6) is less than 24 in (610 mm) OR greater than 75 in (1905 mm), go to the end of the TEST Block. If not, proceed to the next step.
15	<p>Position the clamp tester platens on the smallest faces (face 5 and 6) of the packaged-product 3 in (76 mm) <u>up</u> and <u>flush</u> with the largest face of the test item as shown in the figure at right</p> 
16	Start moving the clamp tester platens toward each other at a consistent rate to apply a horizontal compression force to the smallest faces of the test item. Increase the compression force until it reaches the value determined in Step 4.
17	Raise the test specimen approximately 12" (305 mm) off the floor and maintain the compression force for 30 seconds, then lower the test specimen and release.
18	Repeat Steps #15-17 until a total of 5 force applications to the two smallest faces of the test specimen have been accomplished.
19	Place the Type G or H (TV/Monitor) test specimen on a flat, level surface and in the clamps in its <u>intended shipping orientation</u> . IF the distance between the two largest faces (faces 2 and 4) is less than 24 in (610 mm) OR greater than 75 in (1905 mm), then go to the end of the TEST BLOCK.

Continued on next page.

TEST SEQUENCE FOR PROJECT 6-AMAZON.COM-SIOC

Continued from previous page

COMPRESSION, HORIZONTAL: CLAMPING SIMULATION

TEST BLOCK 9
Compression,
Horizontal:
Clamping
Simulation
(continued)

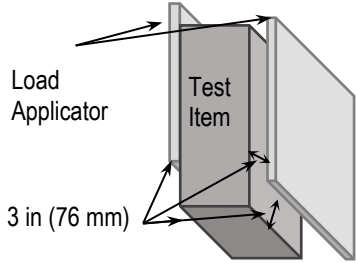
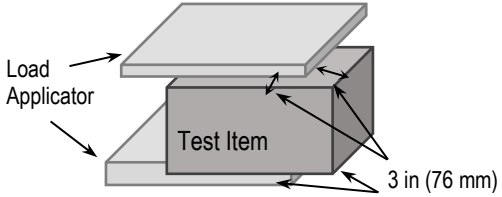
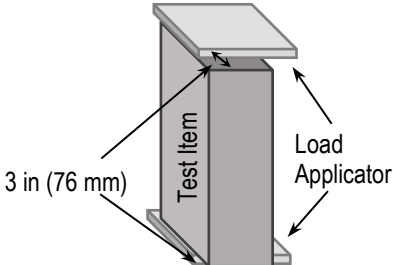
Step	Action	
20	Position the clamp tester platens near the two largest faces (faces 2 and 4), each platen <u>up</u> 3 in (76 mm) and <u>back</u> 3 in (76 mm) from the corners of the test item as shown in the figure at right. Go to next step.	
21	Perform Steps #16 & 17 but applying the clamping force determined in Step #4 of this TEST BLOCK to the largest faces of the test specimen.	
22	Repeat Step #21 of this TEST BLOCK until a total of 5 force applications to the largest faces (faces 2 and 4) of the test specimen have been accomplished then go to the end of the TEST BLOCK.	
23	Place the Type B, C, D, or E test specimen on a flat, level surface. IF the distance between faces 2 and 4 is less than 24 in (610 mm) OR greater than 75 in (1905 mm), go to Step #29. If not, proceed to the next step.	
24	Place a rigid load applicator that is larger than the test specimen (see section of <i>Before You Begin Horizontal Compression Testing -Clamping Simulation</i>) on the lower platen of the compression machine.	
25	Position face 2 of the test specimen on the load applicator so that it overhangs 3 inches (76 mm) in each of the two horizontal dimensions as shown in the figure at right. If the face has dimensions smaller the 6 inches (152 mm), position the sample so it overhangs half of that face dimension. Position a second load applicator on top of the test specimen (face 4) with the same overhang as the bottom load applicator.	
26	Start the compression test machine and select a 50 lb (23 kg) preload. Bring the platens together until the test item is contacted, then continue at the rate of 0.5 in (13 mm) per minute.	
27	Increase the compression force until it reaches the value determined in the <i>Before You Begin Horizontal Compression (Clamping) Testing</i> section or deflection equals 1 in (25 mm) or a 15% force yield.	
28	Repeat Steps #24-27 until a total of 5 force applications to faces 2 and 4 of the test specimen have been accomplished then go to the end of the TEST BLOCK.	
29	Place the Type B, C, D, or E test specimen on a flat, level surface. IF the distance between faces 5 and 6 is less than 24 in (610 mm) OR greater than 75 in (1905 mm), go to the end of the TEST BLOCK. If not, proceed to the next step.	
30	Perform Steps #24-27 but applying the clamping force determined in Step #2 of this TEST BLOCK to packaged-product faces 5 and 6.	
31	Repeat Step #30 of this TEST BLOCK until a total of 5 force applications to faces 5 and 6 of the test specimen have been accomplished then go to the end of the TEST BLOCK.	
32	Place the Type G or H (TV/Monitor) test specimen on a flat, level surface and in its <u>intended shipping orientation</u> . IF the distance between the smallest faces (faces 5 and 6) is less than 24 in (610 mm) OR greater than 75 in (1905 mm), go to the end of the TEST BLOCK. If not, proceed to the next step.	
33	Place a rigid load applicator that is larger than the test specimen (see section of <i>Before You Begin Horizontal Compression Testing -Clamping Simulation</i>) on the lower platen of the compression machine.	
34	Position the smallest face of the test specimen on the load applicator so that it overhangs 3 inches (76 mm) in one of the two horizontal dimensions as shown in the figure at right. If the face has dimensions smaller the 6 inches (152 mm), position the sample so it overhangs half of that face dimension. Position a second load applicator on top of the test specimen (face 4) with the same overhang as the bottom load applicator.	

TEST SEQUENCE FOR PROJECT 6-AMAZON.COM-SIOC

Continued from previous page

COMPRESSION, HORIZONTAL: CLAMPING SIMULATION

TEST BLOCK 9
Compression,
Horizontal:
Clamping
Simulation
(continued)

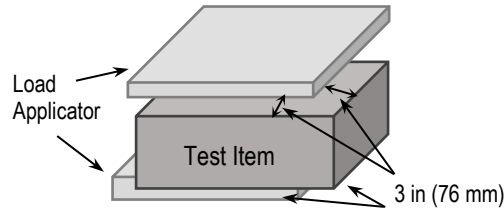
Step	Action	
35	Start the compression test machine and select a 50 lb (23 kg) preload. Bring the platens together until the test item is contacted, then continue at the rate of 0.5 in (13 mm) per minute.	
36	Increase the compression force until it reaches the value determined in the Step #4 or deflection equals 1 in (25 mm) or a 15% force yield.	
37	Repeat Steps #34-36 of this TEST BLOCK until a total of 5 force applications to faces 5 and 6 of the test specimen have been accomplished.	
38	Place the Type G or H (TV/Monitor) test specimen on a flat, level surface with the largest face down. IF the distance between largest faces is less than 24 in (610 mm) OR greater than 75 in (1905 mm), go to the end of the TEST BLOCK. If not, proceed to the next step.	
39	Place a rigid load applicator that is larger than the test specimen (see section of <i>Before You Begin Horizontal Compression Testing -Clamping Simulation</i>) on the lower platen of the compression machine.	
40	<p>Position the largest face of the test specimen on the load applicator so that it overhangs 3 inches (76 mm) in each of the two horizontal dimensions as shown in the figure at right. If the face has dimensions smaller than 6 inches (152 mm), position the sample so it overhangs half of that face dimension. Position a second load applicator on top of the test specimen with the same overhang as the bottom load applicator.</p>	 <p>The diagram illustrates a 3D perspective of a rectangular test item resting on a flat surface. A larger, rectangular load applicator is positioned underneath the test item, extending beyond its edges. Two arrows point to the overhanging parts of the load applicator, with the label 'Load Applicator' and a dimension line indicating '3 in (76 mm)' for the overhang on one side. The test item itself is labeled 'Test Item'.</p>
41	Start the compression test machine and select a 50 lb (23 kg) preload. Bring the platens together until the test item is contacted, then continue at the rate of 0.5 in (13 mm) per minute.	
42	Increase the compression force until it reaches the value determined in Step #4 or deflection equals 1 in (25 mm) or a 15% force yield.	
43	Repeat Steps #40-42 until a total of 5 force applications to the largest faces of the test specimen have been accomplished.	
44	This TEST BLOCK is now complete. Go to TEST BLOCK 10 [Compression: Vertical (Top-to-Bottom)].	

TEST SEQUENCE FOR PROJECT 6-AMAZON.COM-SIOC

TEST BLOCK 10
Compression:
Vertical
(Top-to-Bottom)

COMPRESSION: VERTICAL (TOP-TO-BOTTOM)			
Step	Action		
1	IF the packaged-product type is...	THEN go to...	
	<ul style="list-style-type: none"> • Type B, Parcel Delivery of Individual Packaged-Products 50 lb (23 kg) to Less Than 100 lb (45 kg) or • Type C, Parcel Delivery of Individual Packaged-Products 100 lb (45 kg) or Greater or • Type D, LTL Delivery of Individual Packaged-Products Less Than 100 lb (45 kg) or • Type E, LTL Delivery of Individual Packaged-Products 100 lb (45 kg) or Greater • Type G, Parcel Delivery of TV/Monitor Less Than 150 lb (68 kg) and Girth Less Than 165 in (4.19 m) • Type H, LTL Delivery of TV/Monitor Greater Than 150 lb (45 kg) or Girth Greater Than 165 in (4.19 m) 	Step 2 of this TEST BLOCK.	
	• Type F , LTL Delivery of Individual Palletized Packaged-Products	Step 3 of this TEST BLOCK.	
2	1	Position the packaged-product in its intended shipping orientation for TV/Monitor packaged-products and all other packages where intended shipping orientation is known. If the intended shipping orientation is unknown for packages other than TV/Monitor, place the packaged-product in its most stable orientation. <ul style="list-style-type: none"> • If testing is to be performed with a compression test machine, center the packaged-product on the lower platen of the machine. • If testing is to be performed with weight(s) and a load spreader, place the packaged-product on a smooth, flat, rigid surface. 	
	2	IF testing will be performed with...	THEN go to...
		A compression testing machine	Sequence #3 of this Step below.
		Weight(s) and a load spreader	Sequence #7 of this Step below.
	3	Start the compression test machine and bring the platens together until the test item is contacted, then continue at the rate of 0.5 in (13 mm) per minute.	
	4	Increase the compression force until it reaches the value determined in the <i>Before You Begin Vertical (Top-to-Bottom) Compression Testing</i> section.	
	5	Maintain the force for one hour, then release.	
	6	Go to Step 4 of this TEST BLOCK.	
	7	Smoothly and gently place the weight(s) and load spreader, as described in the <i>Equipment Required Compression</i> section, on top of the test specimen and pallet. The proper weight(s) + load spreader value is determined in the <i>Before You Begin Vertical (Top-to-Bottom) Compression Testing</i> section.	
	8	After 1 hour, remove the weight(s) and load spreader.	
9	Go to Step 4 of this TEST BLOCK.		
3	Sequence #	Action	
	1	Position the packaged-product for compression testing as follows: <ul style="list-style-type: none"> • If testing is to be performed with a compression test machine, center the packaged-product on the lower platen of the machine with face 3 down. • If testing is to be performed with weight(s) and a load spreader, place the packaged-product with face 3 down resting on a smooth, flat, rigid surface. 	
	2	Place a pallet, as described in the <i>Equipment Required Compression</i> section, on top of the test item. Use a standard pallet as described, or if the test item is shipped on a custom pallet, use an identical custom pallet on top. Align the corners of the top pallet with the corners of the bottom pallet (center the top pallet on the test item).	

Continued on next page

TEST SEQUENCE FOR PROJECT 6-AMAZON.COM-SIOC

Continued from previous page

TEST BLOCK 10
Compression:
Vertical
(Top-to-Bottom)
(continued)

COMPRESSION: VERTICAL (TOP-TO-BOTTOM) (continued)			
3	3	IF testing will be performed with...	THEN go to...
		A compression testing machine	Sequence #4 of this Step below.
		Weight(s) and a load spreader	Sequence #8 of this Step below.
	4	Start the compression test machine and bring the platens together until the test item is contacted, then continue at the rate of 0.5 in (13 mm) per minute.	
	5	Increase the compression force until it reaches the value determined in the <i>Before You Begin Vertical (Top-to-Bottom) Compression Testing</i> section.	
	6	Maintain the force for 1 hour, then release.	
	7	Go to Step 4 of this TEST BLOCK.	
	8	Smoothly and gently place the weight(s) and load spreader, as described in the <i>Equipment Required Compression</i> section, on top of the test specimen (and pallet as appropriate). The proper weight(s) + load spreader value is determined in the <i>Before You Begin Vertical (Top-to-Bottom) Compression Testing</i> section.	
	9	Maintain for 1 hour and remove the weight(s) and load spreader as follows:	
	10	Go to Step 4 of this TEST BLOCK	
4	This TEST BLOCK is now complete. Determine the next TEST BLOCK to be used as follows:		
	IF the packaged-product type is...		THEN go to...
	<ul style="list-style-type: none"> • Type B, Parcel Delivery of Individual Packaged-Products 50 lb (23 kg) to Less Than 100 lb (45 kg) or • Type C, Parcel Delivery of Individual Packaged-Products 100 lb (45 kg) or Greater or • Type G, Parcel Delivery of Packaged TV/Monitors Less Than 150 lb (68 kg) and Girth Less Than 165 in (4.19 m) 		Go to TEST BLOCK 12 (Vibration: Random With and Without Top Load).
	<ul style="list-style-type: none"> • Type D, LTL Delivery of Individual Packaged-Products Less Than 100 lb (45 kg) or • Type E, LTL Delivery of Individual Packaged-Products 100 lb (45 kg) or Greater or • Type H, LTL Delivery of TV/Monitor Greater Than 150 lb (68 kg) or Girth 165 in (4.19 m) or Greater 		Go to TEST BLOCK 13 (Vertical Vibration: Random with Top Load).
	Type F , LTL Delivery of Individual Palletized Packaged-Products		TEST BLOCK 11 (Shock: Fork Lift Simulation)

TEST SEQUENCE FOR PROJECT 6-AMAZON.COM-SIOC

TEST BLOCK 11
Shock:
Fork Lift
Simulation

SHOCK: FORK LIFT SIMULATION

Complete this TEST BLOCK for **Type F**, LTL Delivery of Individual Palletized Packaged-Products.

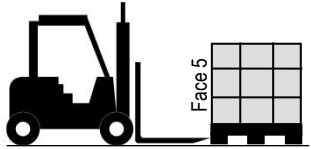
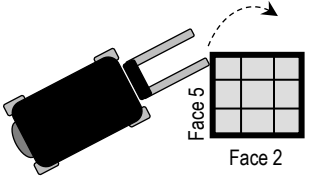
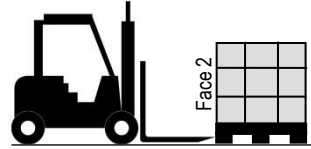
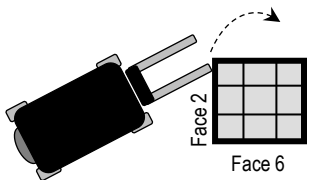
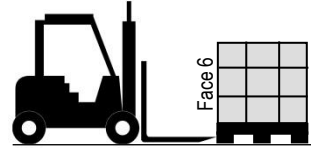
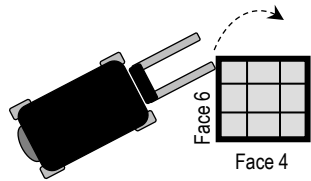
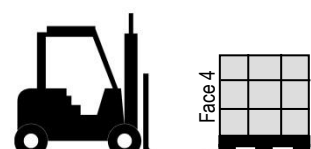
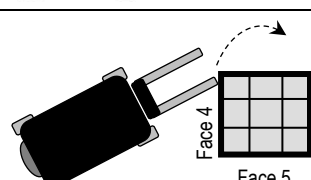
Step	Action		
1	Perform flat push and rotate tests as described in the sequence table below.		
	Sequence #	Action	
	1	Place the Palletized or Skidded packaged-product so that face 3 rests flat on a level floor.	
	2	Align a single fork truck blade tip with the middle pallet/skid stringer or block on side (Face) 5.	
	3	Starting with the blade tip touching the stringer or block nominally half way up its vertical height, push the pallet/skid straight forward a minimum of 40 in (1 m). Push the required distance in approximately 2 to 3 seconds.	
	4	Contact the pallet/skid with one fork blade at corner 3-4-5. Do not lift the pallet/skid.	
	5	Using the fork blade, rotate the pallet/skid 90 degrees from its original orientation.	
	6	Repeat the flat push test of Sequence #1 through 3 of Step 1 of this TEST BLOCK, but push the pallet/skid from side (Face) 2.	
	7	Repeat the flat rotate test of Sequence #4 and 5 of Step 1 of this TEST BLOCK, rotating in the same direction by contacting the pallet/skid at corner 3-2-5.	
	8	Repeat the flat push test of Sequence #1 through 3 of Step 1 of this TEST BLOCK, but push the pallet/skid from side (Face) 6.	
	9	Repeat the flat rotate test of Sequence #4 and 5 of Step 1 of this TEST BLOCK, but rotating in the opposite direction from Sequence #7 by contacting the pallet/skid at corner 3-2-6.	
	10	Repeat the flat push test of Sequence #1 through 3 of Step 1 of this TEST BLOCK, but push the pallet/skid from side (Face) 4.	
	11	Repeat the flat rotate test of Sequence #4 and 5 of Step 1 of this TEST BLOCK, rotating in the same direction as in Sequence #9 by contacting the pallet/skid at corner 3-4-6.	

Continued on next page

Δ – Most recent technical change(s)

O – Most recent technical addition(s)

TEST SEQUENCE FOR PROJECT 6-AMAZON.COM-SIOC

Continued from previous page

TEST BLOCK 11
Handling:
Fork Lift
Simulation
(continued)

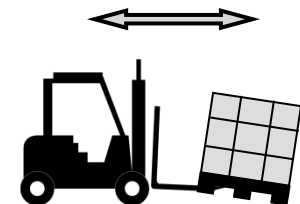
SHOCK: FORK LIFT HANDLING (continued)			
Step	Sequence #	Action	
2	Perform elevated push and pull tests as described in the sequence table below.		
	Sequence #	Action	
	1	Place the Palletized or Skidded packaged-product so that Face 3 rests flat on a level floor.	
	2	Enter the pallet/skid with the fork blades to a depth sufficient to lift one edge and so that the blades will not become disengaged during Sequence #4 (the elevated pull test) below. Lift the edge a minimum of 4 in (100 mm) off the floor, leaving the opposite edge in contact with the floor.	
	3	Push the pallet/skid straight forward a minimum of 40 in (1m). Push the required distance in approximately 2 to 3 seconds.	
	4	Repeat Sequence #1 through 3 of Step 2 of this TEST BLOCK, but <u>pull</u> (rather than <u>push</u>) the pallet/skid.	
5	Repeat Sequence #1 through 4 of Step 2 of this TEST BLOCK for all other possible directions of entry of the pallet/skid; i.e. a total of 2 push-pull tests for a two-way-entry pallet/skid, and a total of 4 push-pull tests for a four-way-entry pallet/skid.		
3	This TEST BLOCK is now complete. Go to TEST BLOCK 14 (Vertical Vibration: Random with Top Load).		

TEST SEQUENCE FOR PROJECT 6-AMAZON.COM-SIOC

VIBRATION: DYNAMIC LOAD, RANDOM (using OVER-THE-ROAD spectrum)

Complete the following test sequence for each type of package that has a check in the box:

- **Type A**, Parcel Delivery of Individual Packaged-Products Less Than 50 lb (23 kg) or
- **Type B**, Parcel Delivery of Individual Packaged-Products 50 lb (23 kg) to Less Than 100 lb (45 kg) or
- **Type C**, Parcel Delivery of Individual Packaged-Products 100 lb (45 kg) or Greater
- **Type G**, Parcel Delivery of Packaged TV/Monitors Less Than 150 lb (68 kg) and Girth Less Than 165 in (4.19 m)

Step	Action	Testing Orientation	Vibration Duration
1	Place the packaged-product on the vibration table so that face-3 rests on the center of the platform.	FACE 3 on table surface	60 MINUTES
2	Place the Dynamic Top-Load apparatus as determined in Before You Begin Vibration Under Dynamic Load for TL-H on top of the test specimen.*		
3	Using some form of column stack fixturing, make sure that the stack will maintain its orientation without restricting the vertical motion of the Top-Load apparatus or the test specimen.		
4	Start the vibration machine to produce the Over-the-Road random vibration spectrum indicated in Before You Begin Vibration Testing.		
5	After 60 minutes, stop the vibration testing and remove the Dynamic Top-Load apparatus.		
6	Rotate the test specimen so that face-4 rests on the center of the vibration table platform.	FACE 4 on table surface	30 MINUTES
7	Place the Dynamic Top-Load apparatus as determined in Before You Begin Vibration Under Dynamic Load Testing for TL-W on top of the test specimen.*		
8	Using some form of column stack fixturing to make sure that the stack maintains its orientation without restricting the vertical motion of the Top- Load apparatus or the test specimen.		
9	Start the vibration machine to produce the Over-the-Road random vibration spectrum indicated in Before You Begin Testing.		
10	After 30 minutes, stop the vibration testing and remove the Dynamic Top-Load apparatus.		
11	Rotate the test specimen so that face-6 rests on the center of the vibration table platform.	FACE 6 on table surface	30 MINUTES
12	Place the Dynamic Top-Load apparatus as determined in Before You Begin Vibration Under Dynamic Load for TL-L on top of the test specimen.		
13	Using some form of column stack fixturing, make sure that the stack will maintain its orientation without restricting the vertical motion of the Top-Load apparatus or the test specimen.		
14	Start the vibration machine to produce the Over-the-Road random vibration spectrum indicated in Before You Begin Vibration Testing.		
15	After the completion of 30 minutes, stop the vibration testing and remove the Dynamic Top-Load apparatus.		

Continued on next page

TEST SEQUENCE FOR PROJECT 6-AMAZON.COM-SIOC

Continued from previous page

TEST BLOCK 12
Vibration
Random
(Pick-up and
Delivery Vehicle)
(continued)

VIBRATION: RANDOM (using PICK-UP AND DELIVERY VEHICLE spectrum) (continued)			
STEP	ACTION	TESTING ORIENTATION	VIBRATION DURATION
16	Place the packaged-product on the center of the vibration table so that face-3 rests on the platform.	FACE 3 on table surface	30 MINUTES
17	Do not place a Dynamic Top-Load apparatus on top of the test specimen.		
18	Start the vibration machine to produce the Pick-Up and Delivery Vehicle random vibration spectrum indicated in Before You Begin Vibration Testing.		
19	After the completion of 30 minutes, stop the vibration testing.		
20	This TEST BLOCK is now complete. Determine the next TEST BLOCK to be used as follows:		
	IF the packaged-product type is...	THEN go to...	
	Type A , Parcel Delivery of Individual Packaged-Products Less Than 50 lb (23 kg) or Type B , Parcel Delivery of Individual Packaged-Products 50 lb (23 kg) to Less Than 100 lb (45 kg) or Type G , Parcel Delivery of TV/Monitor Less than 100 lbs (45 kg)	TEST BLOCK 15 (Shock: Free-Fall Drop).	
	Type C , Parcel Delivery of Individual Packaged-Products 100 lb (45 kg) or Greater Type G , Parcel Delivery of TV/Monitor 100 lbs (45 kg) or Greater	TEST BLOCK 20 (Shock: Inclined or Horizontal Impact).	

* If the test item is an elongated packaged-product with a non-rectangular cross-section (round tube, triangular tube, etc.), **do not** use a Dynamic Top-Load in the large-face-down orientations.

TEST BLOCK 13
Vibration: Random
with Top Load,
LTL Delivery
(Steel Spring
Truck spectrum)

TEST SEQUENCE FOR PROJECT 6-AMAZON.COM-SIOC

VIBRATION: DYNAMIC LOAD, RANDOM (using STEEL SPRING TRUCK spectrum)

Complete this TEST BLOCK for the following type of packaged-product only:

- **Type D**, LTL Delivery of Individual Packaged-Products Less Than 100 lb (45 kg) or
- **Type E**, LTL Delivery of Individual Packaged-Products 100 lb (45 kg) or Greater
- **Type H**, LTL Delivery of TV/Monitor Greater Than 150 lb (68 kg) or Girth 165 in (4.19 m) or Greater

Step	Action	Testing Orientation	Vibration Duration in Minutes
1	Place the packaged-product on the center of the vibration table so that Face 3 rests on the platform.	Face 3 on table surface	80 Minutes
2	Place the Top Load Apparatus TL-H , as determined in <i>Before You Begin Vibration Testing</i> , on top of the test specimen. Note: <ul style="list-style-type: none"> • If the vertical dimension of the packaged-product in this orientation is 72 in (1.8 m) or greater, do not use a Top Load apparatus for this orientation during vibration testing. • If the calculated total theoretical top load for any axis is less than 25 lb (11 kg), do not use a Top Load Apparatus for that axis during vibration testing. • The maximum total Top Load Apparatus weight to be used for any axis is 600 lb (272 kg). • For small and light packaged-products there is a reduced theoretical top load. • For large packaged-products the top load is divided. 		
3	Use some means, as described in <i>Equipment Required Vibration</i> , to maintain proper alignment of the Top Load Apparatus on the test item without restricting vertical motion of either the Apparatus or the test item.		
4	Start the vibration machine to produce the "ISTA Steel Spring Truck Random Vibration" specified in the <i>Before You Begin Vertical Random Vibration Testing</i> section.		
5	After the prescribed Test Time, stop the test and remove the Top Load Apparatus.		
6	Repeat Steps 1 through 5 of this TEST BLOCK, but with Face 4 of the packaged-product down, and with Top Load Apparatus TL-W applied.	Face 4 on table surface	80 Minutes
7	Repeat Steps 1 through 5 of this TEST BLOCK, but with Face 6 of the packaged-product down, and with Top Load Apparatus TL-L applied.	Face 6 on table surface	80 Minutes
8	This TEST BLOCK is now complete. Determine the next TEST BLOCK to be used as follows:		
	IF the packaged-product...	THEN ...	
	Type D , LTL Delivery of Individual Packaged-Products Less Than 100 lb (45 kg) Type H , LTL Delivery of TV/Monitor Less Than 100 lb (45 kg)	Go to TEST BLOCK 16 (Shock: Free-Fall Drop)	
Type E , LTL Delivery of Individual Packaged-Products 100 lb (45 kg) or Greater Type H , LTL Delivery of TV/Monitor 100 lb (45 kg) or Greater	Go to TEST BLOCK 20 (Shock: Inclined or Horizontal Impact)		

TEST BLOCK 14
Vibration: Random
with Top Load,
LTL Delivery
(Steel Spring
Truck spectrum)

TEST SEQUENCE FOR PROJECT 6-AMAZON.COM-SIOC

VIBRATION: DYNAMIC LOAD, RANDOM (using STEEL SPRING TRUCK spectrum)			
Complete this TEST BLOCK for Type F , LTL Delivery of Individual Palletized Packaged-Products.			
Step	Action	Testing Orientation	Vibration Duration in Minutes
1	Place the packaged-product on the center of the vibration table so that Face 3 rests on the platform.	Face 3 on table surface	240 Minutes
2	Place the Top Load Apparatus TL-H , as determined in <i>Before You Begin Vibration Testing</i> , on top of the test specimen. Note: <ul style="list-style-type: none"> • If the vertical dimension of the packaged-product is 72 in (1.8 m) or greater, do not use a Top Load apparatus during this vibration testing. • The maximum total Top Load Apparatus weight to be used is 600 lb (272 kg). • For large packaged-products the top load is divided. See <i>Equipment Required Vibration</i> and <i>Before You Begin Vibration Testing</i>. • If the exact nature and configuration of stacking loads in shipment is known (for example, identical units loads are always stacked), it may be desirable to use those actual top loads for testing. 		
3	Use some means, as described in <i>Equipment Required Vibration</i> , to maintain proper alignment of the Top Load Apparatus on the test item without restricting vertical motion of either the Apparatus or the test item.		
4	Start the vibration machine to produce the "ISTA Steel Spring Truck Random Vibration" specified in the <i>Before You Begin Vertical Random Vibration Testing</i> section.		
5	After the prescribed Test Time, stop the test and remove the Top Load Apparatus.		
6	This TEST BLOCK is now complete. Go to TEST BLOCK 17 (Shock: Rotational Flat Drop)		

TEST SEQUENCE FOR PROJECT 6-AMAZON.COM-SIOC

TEST BLOCK 15
Shock:
Drop,
Parcel Carrier
(Second
Sequence)

SHOCK: FREE-FALL DROP, PARCEL CARRIER (Second Sequence)

Complete this TEST BLOCK for the following types of packaged-products only, using the drop heights indicated:

- **Type A**, Parcel Delivery of Individual Packaged-Products Less Than 50 lb (23 kg) or
- **Type B**, Parcel Delivery of Individual Packaged-Products 50 lb (23 kg) to Less Than 100 lb (45 kg)
- **Type G***, Parcel Delivery of TV/Monitor Less Than 150 lb (68 kg) and Girth Less Than 165 in (4.19 m)

***Note: For package Type G, do not catch the package after each free-fall impact.**

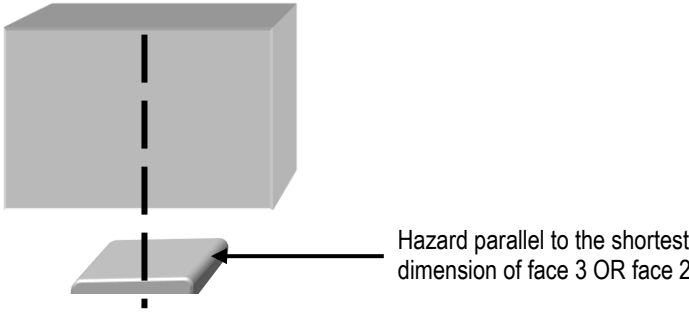
STEP	ACTION			
1	Follow the table below to determine the height and orientation for the final set of 8 drops			
	Drop Number	Drop Height		Test Specimen
		< 70 lb (32 kg)	70 - 150 lb (32 - 68 kg)	Orientation
	10	18 in (460 mm)	12 in (300 mm)	Edge 3-4
	11	18 in (460 mm)	12 in (300 mm)	Edge 3-6
	12	18 in (460 mm)	12 in (300 mm)	Edge 1-5
	13	18 in (460 mm)	12 in (300 mm)	Corner 3-4-6
	14	18 in (460 mm)	12 in (300 mm)	Corner 1-2-6
	15	18 in (460 mm)	12 in (300 mm)	Corner 1-4-5
	16	36 in (910 mm)	24 in (610 mm)	Most critical or damage-prone flat orientation If most critical orientation is unknown for Type G , Face 6 should be used.
17	18 in (460 mm)	12 in (300 mm)	Standard: Face 3 on hazard Elongated or Flat: Face 2 on hazard	
<p>For drop 17, the test specimen should strike the hazard midpoint across the longest dimension of the face and parallel to the shortest dimension of the face being impacted. The required drop distance is to the impact surface, not to the hazard. The diagram below shows this concept:</p> <div style="text-align: center;">  </div>				
2	IF the test specimen type is:	THEN:		
	TV/Monitor	This Test Block is now complete. Go to TEST BLOCK 24 (Shock: Concentrated Edge Impact)		
	Elongated or Flat	This TEST BLOCK is now complete. Go to TEST BLOCK 21 (Shock: Rotational Edge Drop)		
	Not Elongated or Flat AND contains Liquids	This TEST BLOCK is now complete. Go to TEST BLOCK 25 (Integrity: Leak Test)		
	Not Elongated or Flat AND does not contain Liquids	All testing is now complete. Go to the Reporting an ISTA Test section at the end of this Procedure.		

TEST SEQUENCE FOR PROJECT 6-AMAZON.COM-SIOC

TEST BLOCK 16
Shock:
Free-Fall Drop,
LTL Carrier
(Second
Sequence)

SHOCK: FREE-FALL DROP, LTL CARRIER (SECOND SEQUENCE)

Complete this TEST BLOCK for **Type D**, LTL Delivery of Individual Packaged-Products Less Than 100 lb (45 kg) or **Type H**, LTL Delivery of TV/Monitor Less Than 100 lb (45 kg)

Step	Action		
1	Perform 6 drop tests of the individual case or unit, in accordance with the table below and in the order listed. Note: For package Type D, do not catch the package after each free-fall impact.		
	Drop Number	Drop Heights	Orientation of Drop
	1	18 in (460 mm)	Edge 2-3
	2	18 in (460 mm)	Corner 3-4-6
	3	18 in (460 mm)	Edge 4-5
	4	18 in (460 mm)	Corner 1-4-6
	5	18 in (460 mm)	Edge 1-6
6	32 in (810 mm)	Face 3	
2	This TEST BLOCK is now complete. Go to TEST BLOCK 22 (Shock: Full Rotational FLAT Drop).		

TEST BLOCK 17
Shock:
Rotational
FLAT Drop

SHOCK: ROTATIONAL FLAT DROP

Complete this TEST BLOCK for **Type F**, LTL Delivery of Individual Palletized Packaged-Products.

The test is performed starting with the test item resting on a flat, rigid surface such as steel or concrete. Lift one edge to the prescribed drop height. Quickly release the edge so that the test item falls freely.

If the packaged-product in a particular orientation topples over before a side or edge can be lifted to the required drop height, then the rotational drop is not possible.

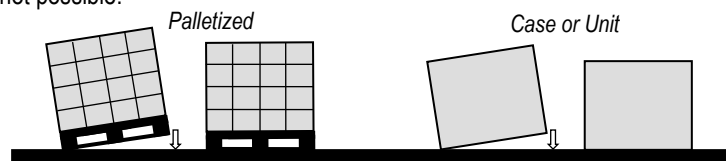

Step	Action	
1	The drop height required for this test as follows: 9 in (230 mm)	
2	Sequence #	Action
	1	Place the packaged-product on a flat, rigid surface such as steel or concrete with face 3 down.
	2	Lift edge 3-6 to the drop height prescribed in Step 1 of this TEST BLOCK. Quickly release the edge so that it falls freely.
	3	Lift edge 3-2 to the drop height prescribed in Step 1 of this TEST BLOCK. Quickly release the edge so that it falls freely.
3	This TEST BLOCK is now complete. Go to TEST BLOCK 18 (Shock: Rotational EDGE Drop).	

TEST SEQUENCE FOR PROJECT 6-AMAZON.COM-SIOC

TEST BLOCK 18
Shock:
Rotational
EDGE Drop

SHOCK: ROTATIONAL EDGE DROP

Complete this TEST BLOCK for **Type F**, LTL Delivery of Individual Palletized Packaged-Products.

The test is performed on a flat, rigid surface such as steel or concrete. One edge is supported with a timber or equivalent support, the opposite edge is lifted and then released quickly so that it falls freely and strikes the surface.

If the packaged-product in a particular orientation topples over before a side or edge can be lifted to the required support or drop height, then the rotational drop is not possible.

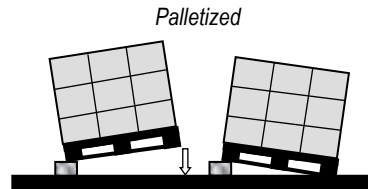

Step	Action	
1	The drop height required for this test as follows: 9 in (230 mm)	
2	Sequence #	Action
	1	Place the packaged-product on a flat, rigid surface such as steel or concrete with face 3 down.
	2	Place edge 3-5 on a timber or equivalent support 3.5 to 4.0 in (90 to 100 mm) in height. Lift edge 3-6 to the drop height prescribed in Step 1 of this TEST BLOCK. Quickly release the edge so that it falls freely.
	3	Place edge 3-4 on a timber or equivalent support 3.5 to 4.0 in (90 to 100 mm) in height. Lift edge 3-2 to the drop height prescribed in Step 1 of this TEST BLOCK. Quickly release the edge so that it falls freely.
3	This TEST BLOCK is now complete. Go to TEST BLOCK 19 (Shock: Rotational CORNER Drop).	

TEST BLOCK 19
Shock:
Rotational
CORNER Drop

SHOCK: ROTATIONAL CORNER DROP

Complete this TEST BLOCK for **Type F**, LTL Delivery of Individual Palletized Packaged-Products.

The test is performed on a flat, rigid surface such as steel or concrete. One corner is supported with a timber or equivalent support, the opposite corner is lifted and then released quickly so that it falls freely and strikes the surface.

If the packaged-product in a particular orientation topples over before a corner can be lifted to the required support or drop height, then the rotational drop is not possible.



Step	Action	
1	The drop height required for this test as follows: 9 in (230 mm)	
2	Sequence #	Action
	1	Place the packaged-product on a flat, rigid surface such as steel or concrete with face 3 down.
	2	Place corner 3-2-6 on a timber or equivalent support 3.5 to 4.0 in (90 to 100 mm) in height. Lift corner 3-4-5 to the drop height prescribed in Step 1 of this TEST BLOCK. Quickly release the edge so that it falls freely.
	3	Place corner 3-4-6 on a timber or equivalent support 3.5 to 4.0 in (90 to 100 mm) in height. Lift corner 3-2-5 to the drop height prescribed in Step 1 of this TEST BLOCK. Quickly release the edge so that it falls freely.
	4	Go to Step 4 of this TEST BLOCK.

3	This TEST BLOCK is now complete. Go to TEST BLOCK 20 (Shock: Inclined or Horizontal Impact).
---	--

TEST SEQUENCE FOR PROJECT 6-AMAZON.COM-SIOC

SHOCK: INCLINED OR HORIZONTAL IMPACT

Complete this TEST BLOCK for the following packaged-products:

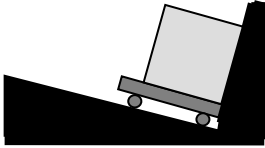
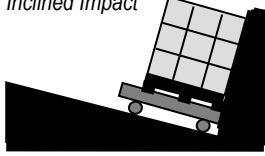
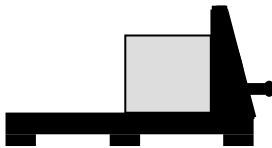
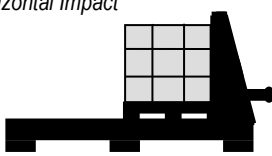
Step	Action	THEN go to...								
1	<p>IF the packaged-product type is...</p> <ul style="list-style-type: none"> • Type C, Parcel Delivery of Individual Packaged-Products 100 lb (45 kg) or Greater or • Type E, LTL Delivery of Individual Packaged-Products 100 lb (45 kg) or Greater • Type G, Parcel Delivery of TV/Monitor Individual Packaged-Products Greater than 100 lbs (45 kg) • Type H, LTL Delivery of TV/Monitor Individual Packaged-Products Greater Than 100 lb (45 kg) 	Step 2 of this TEST BLOCK.								
	<ul style="list-style-type: none"> • Type F, LTL Delivery of Individual Palletized Packaged-Products 	Step 3 of this TEST BLOCK.								
2	<p>Center the packaged-product in the proper orientation (see below) on the carriage, with its front surface in contact with the backstop or sail and parallel to the leading edge of the carriage.</p> <p>Impact (3) of the packaged-product's faces as described in Step 4 of this TEST BLOCK. Impact the faces in the following order: Face 2, Face 3, Face 4. Then go to Step 5 of this TEST BLOCK.</p>									
3	<p>Center the packaged-product in the proper orientation (see below) on the carriage, with its front surface in contact with the backstop or sail and parallel to the leading edge of the carriage. If the packaged-product is a palletized load and the load footprint is smaller than the pallet top surface (an underhung load), place the front edge of the pallet in contact the backstop or sail and parallel to the leading edge of the carriage. In this case there will be a gap between the front surface of the load and the backstop or sail.</p> <p>Impact test each of the packaged-product's vertical faces as described in Step 4 of this TEST BLOCK. Impact the faces in the following order: Face 4, Face 5. Then go to Step 5 of this TEST BLOCK.</p>									
4	<p>Draw the carriage back and impact test the packaged-product on each of the faces as directed. The minimum required <i>impact velocity</i> for an inclined-impact test is 48 in/sec (4 ft/sec) (1.2 m/sec). The minimum required <i>velocity change</i> for a horizontal impact test is 48 in/sec (4 ft/sec) (1.2 m/sec) and the shock must be a nominal 10 millisecond half sine pulse. If any velocity in the Test Sequence is below the required minimum value, that sequence event must be repeated until the test velocity meets the minimum.</p> <div style="display: flex; justify-content: space-around; align-items: center;"> <div style="text-align: center;">  <p>Inclined Impact</p>  </div> <div style="text-align: center;">  <p>Horizontal Impact</p>  </div> </div>									
5	<p>This TEST BLOCK is now complete. Determine the next TEST BLOCK to be used as follows:</p> <table border="1" style="width: 100%; border-collapse: collapse;"> <thead> <tr> <th style="width: 50%;">IF the packaged-product...</th> <th style="width: 50%;">THEN ...</th> </tr> </thead> <tbody> <tr> <td>Type C, Parcel Delivery of Individual Packaged-Products 100 lb (45 kg) or Greater</td> <td>Go to TEST BLOCK 21 (Shock: Rotational Edge Drop)</td> </tr> <tr> <td>Type E, LTL Delivery of Individual Packaged-Products 100 lb (45 kg) or Greater</td> <td>Go to TEST BLOCK 23 (Shock: Bridge Impact)</td> </tr> <tr> <td>Type F, LTL Delivery of Individual Palletized Packaged-Products</td> <td>Go to TEST BLOCK 24 (Shock: Concentrated Edge Impact)</td> </tr> </tbody> </table>		IF the packaged-product...	THEN ...	Type C , Parcel Delivery of Individual Packaged-Products 100 lb (45 kg) or Greater	Go to TEST BLOCK 21 (Shock: Rotational Edge Drop)	Type E , LTL Delivery of Individual Packaged-Products 100 lb (45 kg) or Greater	Go to TEST BLOCK 23 (Shock: Bridge Impact)	Type F , LTL Delivery of Individual Palletized Packaged-Products	Go to TEST BLOCK 24 (Shock: Concentrated Edge Impact)
IF the packaged-product...	THEN ...									
Type C , Parcel Delivery of Individual Packaged-Products 100 lb (45 kg) or Greater	Go to TEST BLOCK 21 (Shock: Rotational Edge Drop)									
Type E , LTL Delivery of Individual Packaged-Products 100 lb (45 kg) or Greater	Go to TEST BLOCK 23 (Shock: Bridge Impact)									
Type F , LTL Delivery of Individual Palletized Packaged-Products	Go to TEST BLOCK 24 (Shock: Concentrated Edge Impact)									

Type H, TV/Monitor LTL Delivery of Individual Packaged-Products Greater Than 100 lb (45 kg)	Go to TEST BLOCK 22 (Shock: Full Rotational Flat Drop)
---	--

TEST SEQUENCE FOR PROJECT 6-AMAZON.COM-SIOC

TEST BLOCK 21
Shock:
Rotational
Edge Drop

SHOCK: ROTATIONAL EDGE DROP			
Complete the following test sequence for each type of package that are Flat or Elongated (ONLY) :			
<ul style="list-style-type: none"> • Type A, Parcel Delivery of Individual Packaged-Products Less Than 50 lb (23 kg) or • Type B, Parcel Delivery of Individual Packaged-Products 50 lb (23 kg) to Less Than 100 lb (45 kg) or • Type C, Parcel Delivery of Individual Packaged-Products 100 lb (45 kg) or Greater 			
STEP	ACTION		
1	Perform three rotational edge drops according to the sequence in the table below.		
	Sequence #	Orientation	Specific edge
	1	Edge	One of the longest face 3 edges
	2	Edge	next longest edge radiating 90° from the edge just tested
	3	Edge	The opposite edge tested in Sequence 2.
2	Place the package with face 3 down onto a flat, rigid surface such as steel or concrete.		
3	Support the face 3 edge that is opposite the face 3 edge that is to be tested with a timber or support 3.5 to 4.0 in (90 to 100 mm) in height and width.		
4	Lift the face 3 edge that is to be tested according to sequence in Step 1 to 9 in (230 mm) off the surface.		
5	Release the edge that is to be tested so that it falls freely onto a flat, rigid surface.		
6	Repeat Step 3 through Step 5 to complete additional edge drops according to the sequence in Step 1.		
7	This TEST BLOCK is now complete. Go to TEST BLOCK 22 (Shock – Full Rotational Flat Drop).		

TEST BLOCK 22
Shock:
Full Rotational
Drop

SHOCK: FULL ROTATIONAL FLAT DROP			
Complete this test sequence for the following types of packaged-products only:			
<ul style="list-style-type: none"> • Type A, Type B, Type C or Type D that are Flat or Elongated or Type H 			
STEP	ACTION		
1	Place the packaged-product so that one of the smallest faces rests on a rigid surface such as steel or concrete and in a position that when pushed over the face 3 surface will impact the rigid surface. For a TV/Monitor, the Face which has the screen should impact the rigid surface.		
2	Using any method apply just enough force to the upper half of face 1 to push over the packaged-product without moving the packaged-product from its position.		
3	Place the packaged-product so that one of the next largest faces rests on a rigid surface such as steel or concrete and in a position that when pushed over the face 3 surface will impact the rigid surface.		
4	Using any method apply just enough force to the upper half of face 1 to push over the packaged-product without moving the packaged-product from its position.		
5	This TEST BLOCK is now complete. Determine the next TEST BLOCK to be used as follows:		
	IF the test specimen type is ...	THEN ...	
	Elongated	Go to TEST BLOCK 23 (Shock: Bridge Impact).	
	<ul style="list-style-type: none"> • Flat • TV/Monitor 	Go to TEST BLOCK 24 (Shock: Concentrated Edge Impact).	

TEST SEQUENCE FOR PROJECT 6-AMAZON.COM-SIOC

SHOCK - BRIDGE IMPACT

Complete this test sequence for the following types of packaged-products only:

- **Type A, Type B, Type C, Type D, Type E or Type F** that are **Elongated**

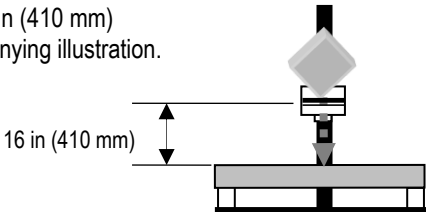
STEP	ACTION	
1	Place the packaged-product so that Face 3 rests on two separate support blocks (as described in <i>Equipment Required Shock</i>), which are on opposite ends of the longest dimension parallel to each other and the shortest edges.	
2	Position the Hazard Box above the packaged-product in an edge-drop orientation with the reinforced edge down and perpendicular to the packaged-product's longest dimension. Carefully align the Hazard Box so that the midpoint of the packaged-product Face 1 is directly under the midpoint of the Hazard Box's reinforced edge.	
3	Drop the Hazard Box onto the packaged-product from a distance of 16 in (410 mm) as measured from the packaged-product's top Face. See the accompanying illustration. 	
4	This TEST BLOCK is now complete. Determine the next TEST BLOCK to be used as follows:	
	IF the test specimen type is ...	THEN ...
	Type A , Parcel Delivery of Individual Packaged-Products Less Than 50 lb (23 kg) or Type B , Parcel Delivery of Individual Packaged-Products 50 lb (23 kg) to Less Than 100 lb (45 kg) or	Go to TEST BLOCK 25 (Integrity: Leak Test).
	Type C , Parcel Delivery of Individual Packaged-Products 100 lb (45 kg) or Greater or Type D , LTL Delivery of Individual Packaged-Products Less Than 100 lb (45 kg) or Type E , LTL Delivery of Individual Packaged-Products 100 lb (45 kg) or Greater or Type F , LTL Delivery of Individual Palletized Packaged-Products	All testing is now complete. Go to the Reporting an ISTA Test section at the end of this Procedure.

TEST SEQUENCE FOR PROJECT 6-AMAZON.COM-SIOC

SHOCK - CONCENTRATED EDGE IMPACT

Complete this test sequence for the following types of packaged-products only:

- **Type A, Type B, Type C, Type D, Type E or Type F** that are **Flat and all TV/Monitors Type G and Type H**

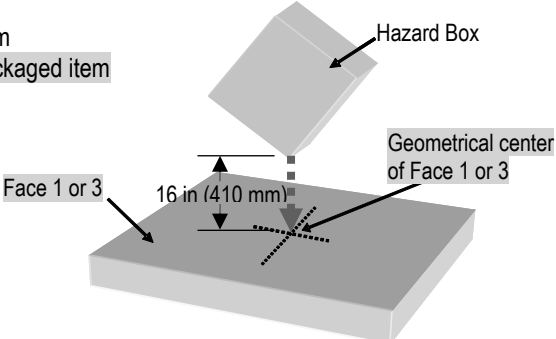
STEP	ACTION	
1	Place the packaged-product so that Face 3 rests on a rigid surface such as steel or concrete. For TV/Monitor Face 1 rests on the rigid surface as the Hazard Box will make impact to the screen.	
2	Position the Hazard Box above the packaged-product in an edge-drop orientation with the reinforced edge down, parallel to the packaged-product's Face 1 surface and parallel with its width dimension. Carefully align the Hazard Box so that the geometrical center of the packaged-product's Face 1 is directly under the midpoint of the Hazard Box's reinforced edge or Face 3 if the packaged product is a TV/Monitor.	
3	<p>Drop the Hazard Box onto the packaged-product from a distance of 16 in (410 mm) as measured from Face 1 of the packaged-product or Face 3 if the packaged item is a TV/Monitor.</p> <p>See the accompanying illustration.</p> 	
4	This TEST BLOCK is now complete. Determine the next TEST BLOCK to be used as follows:	
	IF the test specimen type is ...	THEN ...
	Type A , Parcel Delivery of Individual Packaged-Products Less Than 50 lb (23 kg) or Type B , Parcel Delivery of Individual Packaged-Products 50 lb (23 kg) to Less Than 100 lb (45 kg)	Go to TEST BLOCK 25 (Integrity: Leak Test).
	Type C , Parcel Delivery of Individual Packaged-Products 100 lb (45 kg) or Greater or Type D , LTL Delivery of Individual Packaged-Products Less Than 100 lb (45 kg) or Type E , LTL Delivery of Individual Packaged-Products 100 lb (45 kg) or Greater or Type F , LTL Delivery of Individual Palletized Packaged-Products Type G , Parcel Delivery of TV/Monitor Weight Less Than 150 lb (68 kg) and Girth Less Than 165 in (4.19 m) Type H , LTL Delivery of TV/Monitor Weight Greater Than 150 lb (68 kg) or Girth Greater Than 165 in (4.19 m)	All testing is now complete. Go to the Reporting an ISTA Test section at the end of this Procedure.

INTEGRITY – LEAK TEST

Complete this test sequence for **Type A and Type B** packaged-products **ONLY if Liquids are present in the Product**.

If no Liquids are present in the Product, proceed to Step 5.

STEP	ACTION	TESTING ORIENTATION	DURATION
1	Open the TEST SAMPLES and remove ALL primary packages that contain liquids.	Primary Liquid Container on its Side	8 HOURS
2	Place the primary liquid packaging on a solid flat surface with the product horizontal (product would leak if closure was removed).		
3	After the completion of eight (8) hours, inspect the primary liquid container for any leakage.		
4	All primary packages containing liquids from all five (5) Test Samples must be leak free to be considered a PASS.		
5	All testing is now complete. Go to the Reporting an ISTA Test section at the end of this Procedure.		

REPORTING AN ISTA TEST

ISTA Test Report Forms may be downloaded by members through the online ISTA Member Center (www.ista.org/members/). Custom forms are also acceptable, but information on an official ISTA Report Form is considered to be the minimum required for any test report submission and consideration. Test report forms should be submitted to ISTA Headquarters by mail, fax or electronically. Test reports should be detailed enough for accurate repeatability of the test.

The packaged-product has satisfactorily passed the test if, upon examination, it meets the Product Damage Tolerance and Package Degradation Allowance determined prior to testing.

ISTA Certified Testing Laboratories:

- Should file a test report on all ISTA Test Procedures or Projects conducted.
- Shall file a test report on all ISTA Test Procedures or Projects conducted to obtain Transit Tested Package Certification or Acknowledgement.

To submit a test report form:

- Email to ista@ista.org
- Mail to address shown below
- Fax to +1 517-333-3813.

ISTA Transit Tested Program: Packaged-Product Certification

The ISTA Transit Tested Certification Mark as shown:

- is a registered certification mark **and**
- can only be printed on certified packages **and**
- can only be used by license agreement **and**
- by a Shipper member of the International Safe Transit Association.



When a Shipper member prints this certification mark on a packaged-product, with their manufacturer's license number, they are showing their customer, vendors and carriers that it has passed the requirements of ISTA preshipment testing.

To obtain initial certification of a packaged-product:

- the product manufacturer must be a Shipper member of ISTA in good-standing and with a valid License Agreement on file
- the testing laboratory must be a member of ISTA in good-standing and have a valid lab certification date
- a test report must be submitted by the laboratory to ISTA Headquarters.

In order to maintain its certified status and eligibility for identification with the Transit Tested Certification Mark, each packaged-product must be re-tested whenever a change is made in the:

- Product or
- Process or
- Package.

If corrugated packaging is used, it is recommended that the basis weights of the constituent papers/paperboards be determined after testing and documented to provide the best indicator of equivalence or change.

As a quality control procedure, packaged-products should be re-tested frequently, for example, yearly.

For additional information, refer to *Guidelines for Selecting and Using ISTA Test Procedures and Projects*.

ISTA Membership information is available at www.ista.org.

*This Test Project is published by:
International Safe Transit Association
1400 Abbot Road, Suite 160, East Lansing, Michigan 48823-1900 USA*

© 2018 International Safe Transit Association

No part of the contents of this Test Project may be reproduced or transmitted in any form or by any means without the written permission of the publisher.

Order Information: Additional copies of this Test Project and the ISTA® RESOURCE may be ordered online at www.ista.org or by contacting ISTA at (+1) 517.333.3437. A listing of current procedure version dates is available at www.ista.org.